



WIRE ROPE HAND BOOK

Corporate Office

USHA MARTIN LIMITED

2A, Shakespeare Sarani, 'Mangal Kalash', Kolkata - 700071

Phone: +91 33 3980 0300, Fax: +91 33 2282 9029/ 3980 0500

Email: feedback@ushamartin.co.in

CIN: L31400WB1986PLC091621



ushamartin.com

 **usha martin**

FOREWORD

Usha Martin Limited is a Speciality Steel and Steel product focused group with diverse product range in both steel as well as wire rope.

It is one of the largest wire rope manufacturer in the world. It is also the only wire rope company in the world that has a totally integrated business model to convert iron-ore into steel wire ropes as well as build its own wire-drawing and rope-making machinery.

The steel wire ropes ranges from 1.5 mm to 140mm in size, 1370 to 2160 N/mm² in grade and encompassing all constructions and all configurations like Non-Compacted, Compacted, Plasticated, Flattened Strand,

Locked Coil ropes and slings.

Usha Martin ropes conforms to all specifications in the world, viz. ISO, DIN, BS, IS, API, EN, AS, GOST, JIS and approved by all leading organisations, viz. ABS, API, DNV, LLOYDS, NKK.

Usha Martin's rope works is one of the cleanest in the world accredited with TPM excellence award from Japan Institute of Plant Maintenance.

It is one of the very few companies that has approval by OTIS for its worldwide Elevator rope supply.

Usha Martin Steel wire ropes finds place in every corner of the Globe and has presence in almost all application of ropes.

No part of this Book may be reproduced, scanned, stored in a retrieval system or transmitted in any form or by any means, electronic, mechanical, photocopying, recording or otherwise, or reproduced on or by any disc, tape, perforated media or any other storage device or method without the permission in writing from Usha Martin Limited.



WIRE ROPE BASICS



WIRE ROPE COMPONENTS

- WIRE
- STRAND
- CORE

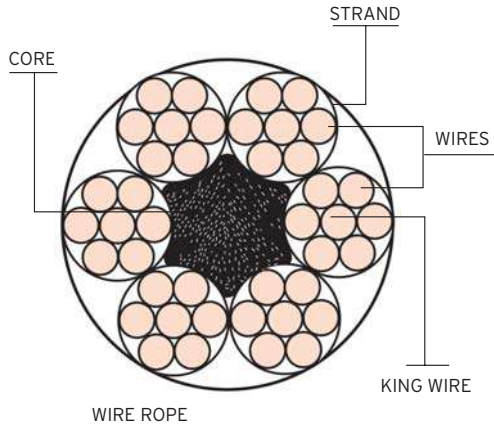

ROPE SIZE

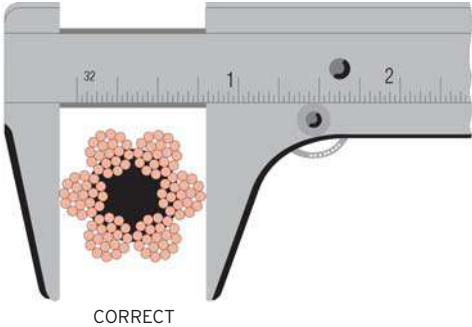

Measure the circle just touching the extreme outer limits (crown) of the strands.

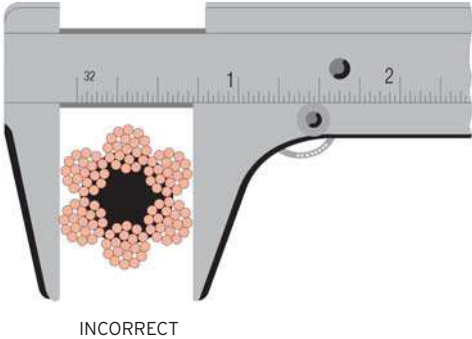

FUNDAMENTAL CONSTRUCTIONS

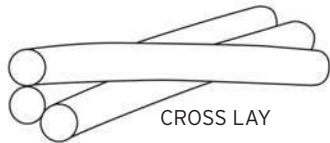

CROSS LAY

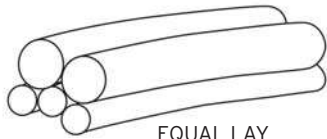

EQUAL LAY

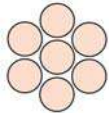

SINGLE LAYER

- Single-Wire centre with six wires of the same diameter.

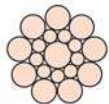

SEALE

- Equal number of wires in each layer.
- All wires in each layer are of the same diameter.
- Large outer wires rest in the valley between the small inner wires.

FUNDAMENTAL CONSTRUCTIONS

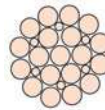

FILLER WIRE

- Inner layer having half the number of wires as the outer layer
- Small filler wires, equal in number to the inner layer, are laid in the valleys of the inner layer.

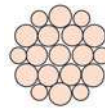

WARRINGTON

- One diameter of wire in the inner layer.
- Two diameters of wire alternating large and small in the outer layer.
- The large outer-layer wires rest in the valleys and the smaller ones on the crowns of the inner layer.

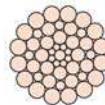

COMBINED

- Combination of above constructions. Eg Seale-Filler, Warrington-Seale etc.



LAY

*Direction of Wire
& Strand Helix*



RIGHT HAND REGULAR LAY (RHRL/RHO/sZ)

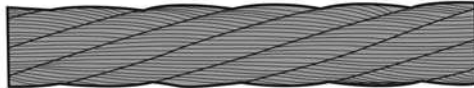

LEFT HAND REGULAR LAY (LHRL/LHO/zS)



RIGHT HAND LANGS LAY (RHLL/RHL/zZ)



LEFT HAND LANGS LAY (LHLL/LHL/sS)



ALTERNATE LAY (COMBINATION OF LANGS & REGULAR)



SPECIAL ALTERNATE LAY (2 LANGS 1 REGULAR)

IDEAL PULLEY GROOVE

Greater contact area between the rope and the pulley reduces abrasion and enhances service life.

WRONG

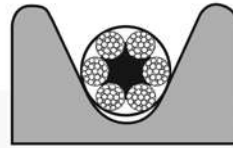

Sheave groove too narrow

WRONG

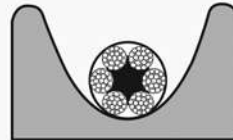

Sheave groove too wide

RIGHT

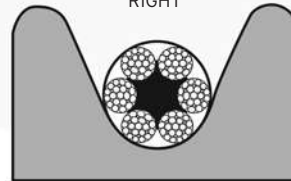

Sheave groove correctly supporting the rope for 33% of its circumference



PULLEY/ROPE BENDING RATIO (D/d RATIO)

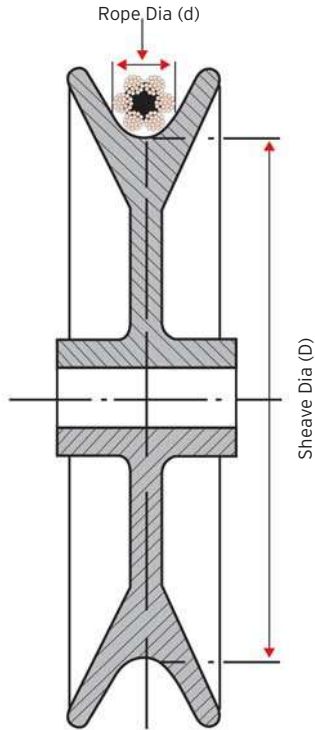

Note:

The ratios are based on Max. rope speed of 60 meters/ min. For each increase of 30 mtrs/min. in excess of 60 meters per min., add 5% to the drum diameter.

SHEAVE OR DRUM/ROPE DIAMETER RATIO (D:d)

Sl. No.	Construction	D : d Ratio	
		Recommended	Minimum
1	6x7 (6-1)	53	43
2	6x19S (9-9-1)	40	32
3	6x26SW (10-5+5-5-1)	37	29
4	6x25F (12-6F-6-1)	32	26
5	6x31SW (12-6+6-6-1)	32	26
6	6x37SF (12-12-6F-6-1)	32	26
7	6x36SW (14-7+7-7-1)	28	22
8	6x43SF (14-14-7F-7-1)	28	22
9	6x50SFS (14-14-7F-7-7-1)	28	22
10	6x41SW (16-8+8-8-1)	25	20
11	6x49SW (16-8+8-8-8-1)	25	20
12	6x49SF (16+16+8F-8-1)	25	20
13	6x46SW (18-9+9-9-1)	22	18
14	6x52SW (18-9+9-9/6-1)	22	18
15	6x55SF (18-18-9F-9/6-1)	23	18
16	8x19S (9-9-1)	33	26
17	8x26SW (10-5+5-5-1)	30	24
18	8x25F (12-6F-6-1)	26	21
19	8x31SW (12-6+6-6-1)	26	21
20	8x37SF (12-12-6F-6-1)	26	21
21	8x36SW (14-7+7-7-1)	23	18
22	8x50SFS (14-14-7F-7-7-1)	23	18
23	17x7 (11:6-1)	34	27
24	18x7 (12:6-FC)	32	25
25	19x7 (12:6-1)	32	25
26	34x7 (17:11/6-FC)	24	19
27	35x7 (16:6+6-6-1)	25	20
28	6x25FS (12/12/▲)	42	35
29	6x8FS (7/▲)	63	53
30	6x28FS (15/12/▲)	36	30
31	Locked Coil Winding Rope	152	100



FLEET ANGLE

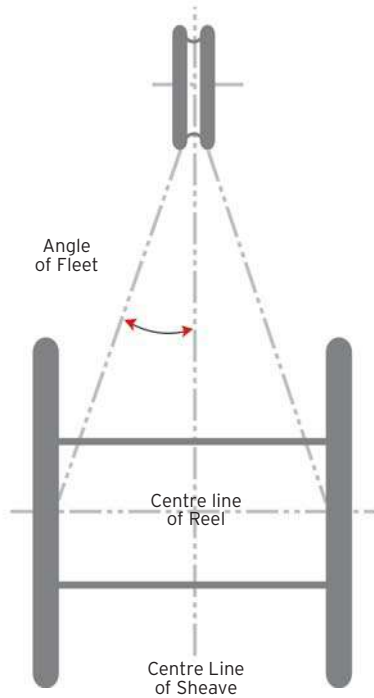

Note:

Recommended angle
 Grooved drum : $\alpha \leq 2.5^\circ$
 Flat drum : $0.5^\circ \leq \alpha \leq 1.5^\circ$

SPOOLING/ANCHORAGE OF ROPE ON DRUM

- Ropes are supplied with zero internal torque
- Improper spooling induces torque in rope, reducing the rope life.

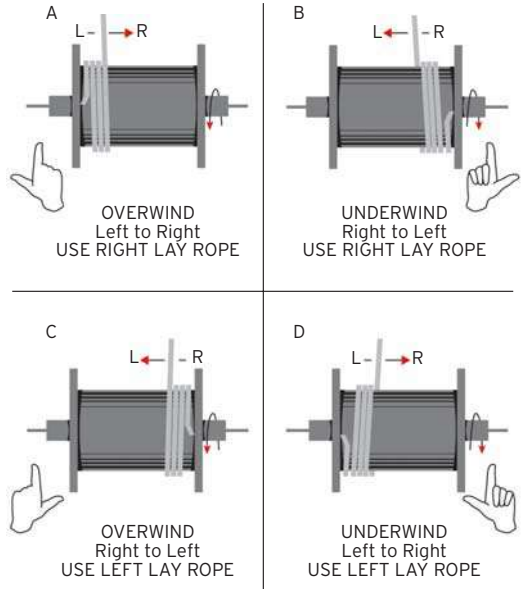

ROPE CUTTING PROCEDURE

- Seizing
- Twisting
- Cutting

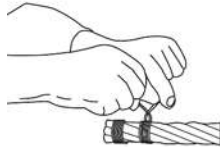

Note:

Seizing wire recommendation

- for ungalvanised rope - use annealed wire
- for galvanised rope - use soft, zinc-coated wire.
- Diameter of wire:
 - 8 - 24 mm = 1 mm
 - 26 - 36 mm = 1.6 mm
 - 38 - 56 mm = 2 mm
- Recommended seizing length = 1 x d min or 10 wraps

ROPE CLAMPING

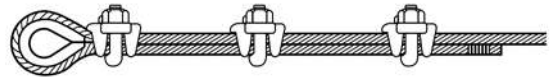

The Right Way to Clip Wire Rope

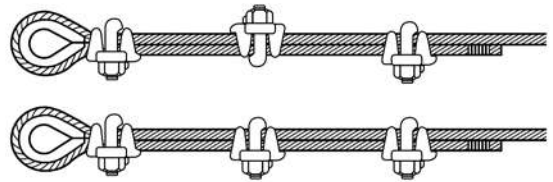

The Wrong Way to Clip Wire Rope

Note:

Improper fixing of clamps may lead to safety hazards. For proper clamping practice, refer applicable standard or OEM recommendations.



IN-USE LUBRICATION

- Usha Martin Ropes are supplied with special lubricant
- Periodic Lubrication during usage is necessary to derive enhanced performance.

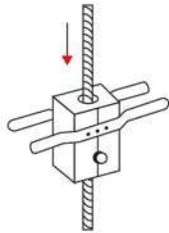

CONTINUOUS BATH

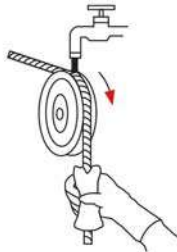

DRIPPING

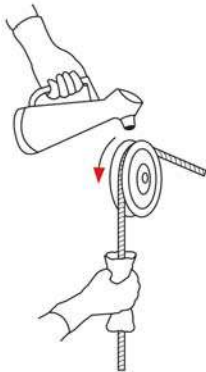

POURING

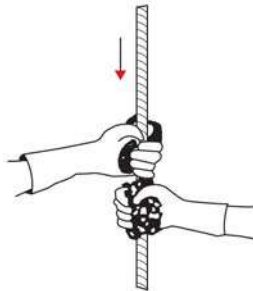

SWABBING

IN-USE LUBRICATION

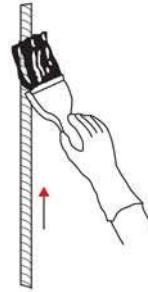

PAINTING

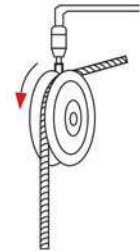

SPRAY NOZZLE

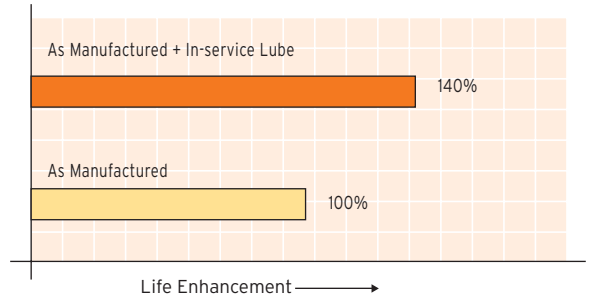

Life Enhancement →

In-use lubrication pays rich dividend



STORAGE

- Must be stored in a well ventilated shed.
- Free from moisture, dust and fumes.
- Suitable lubricant to be applied every 3 months to the outer layers.
- Reel containing ropes to be rolled through 90 degree after every 3 months
- Protect wooden reels from the attack of termites.
- In no case the reels should be put on ground or uncemented floor.

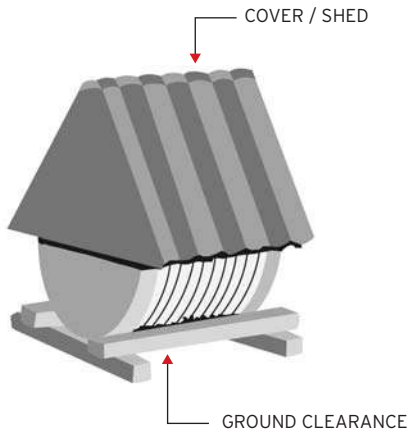

HANDLING - THE RIGHT WAY

- Use spindle through the reels for loading/unloading or put the rope on a swift with brake arrangement.
- Allow clearance for free rotation of reel when the rope end is pulled.
- Maintain constant tension during haul off.
- Prevent crossing of rope laps on the reel.
- Avoid possible kink, which is a permanent damage to a rope.

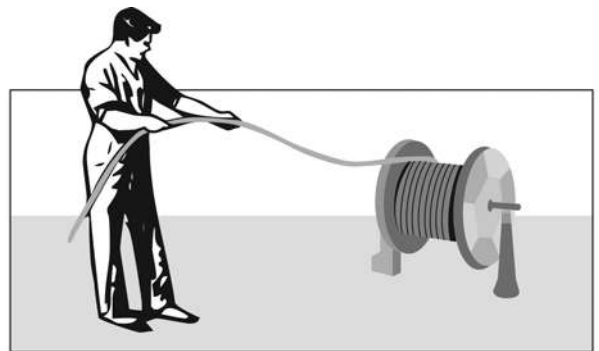

HANDLING THE RIGHT WAY

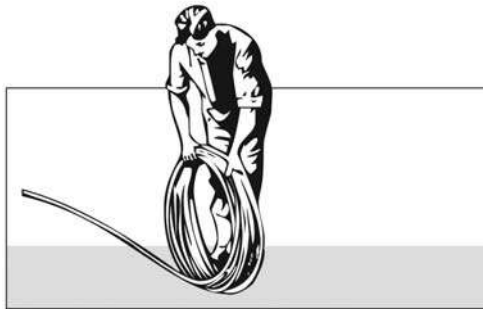
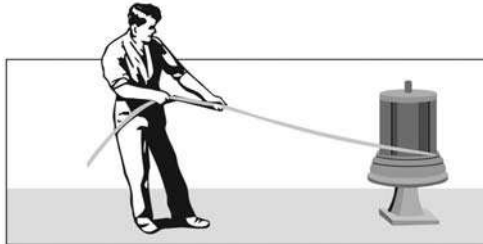
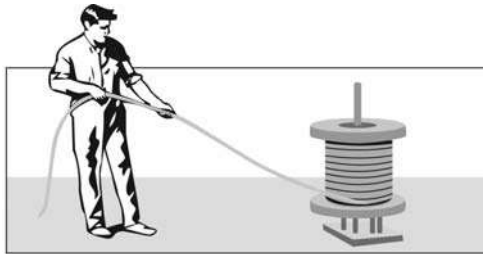

WIRE ROPE CHARACTERISTICS

*BEND FATIGUE
ABRASION RESISTANCE*

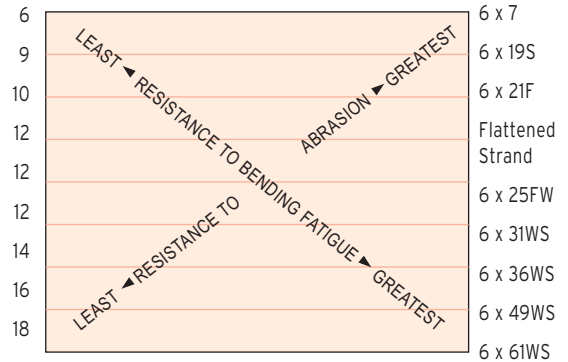

- More wires - better fatigue resistance
- Less wires - better abrasion resistance



WIRE ROPE CHARACTERISTICS

COMMONLY USED NON-COMPACTED ROPES CHARACTERISTICS

- More wires in the outer strand (14 for 36WS) will improve bend fatigue
- Less wires in the outer strands (9 for 19S) improve wear/abrasion resistance characteristics
- Steel core (IWRC) resists drum crushing better than fibre core
- Langs lay resists interference at drum better than ordinary lay

Abrasion Resistance

Comparison of outer wire sizes for 25 mm diameter rope, as illustration

6 x 7	6 outer wires	2.54mm
6 x 19S	9 outer wires	2.11mm
6 x 25F	12 outer wires	1.70mm
6 x 36	14 outer wires	1.49mm
6 x 41	16 outer wires	1.34mm

WIRE ROPE CHARACTERISTICS

COMPARISON OF ROTATION RESISTANCE

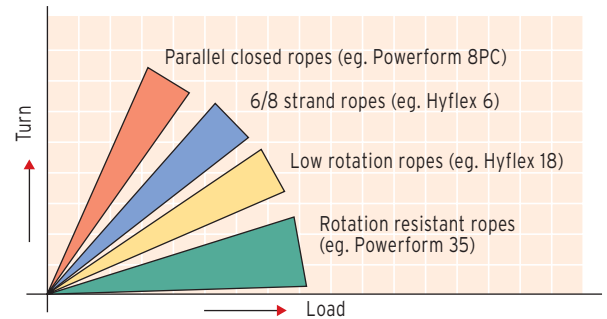
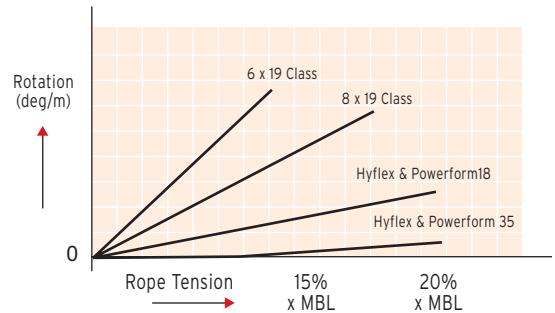

WIRE ROPE CHARACTERISTICS

COMPACTED ROPES CHARACTERISTICS

- Increased breaking force
- Increased performance
- Improved characteristics
 - Improved wear resistance
 - Improved crushing resistance
 - Improved Bend Fatigue resistance

High Breaking Load per unit area

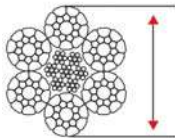

Compacted rope minimum breaking force

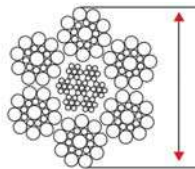

Conventional rope minimum breaking force

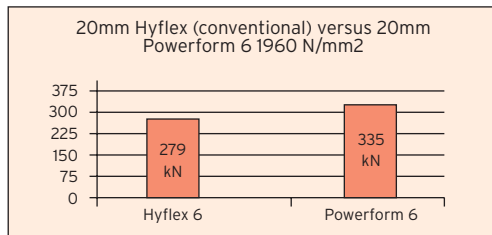

WIRE ROPE CHARACTERISTICS

High Abrasion Resistance

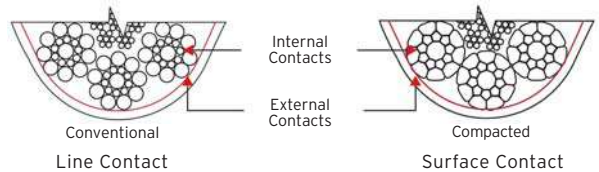

High Crushing Resistance

- At cross-over points due to high fill-factor
- At lower layers in multilayer operation

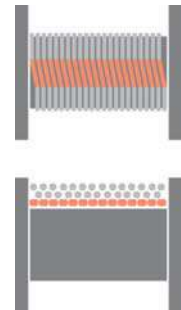

Greater bend fatigue resistance

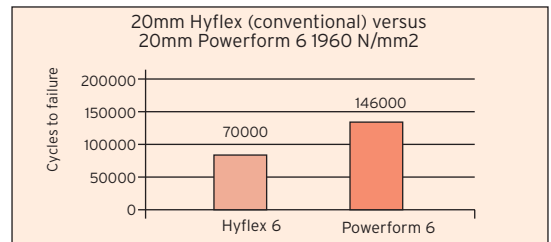

WIRE ROPE CHARACTERISTICS

PLASTICATED ROPE CHARACTERISTICS (Cushion Core - Compacted outer strands)

- Plastic impregnation of core (IWRC)
- Greater resistance to drum crushing
- Increased abrasion resistance
- Smoother exteriors and greater surface area resulting in reduced sheave wear
- Reduced IWRC and outer-strand nicking & crosscutting
- High fatigue life

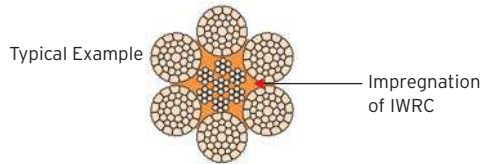

Comparison of bend fatigue illustration

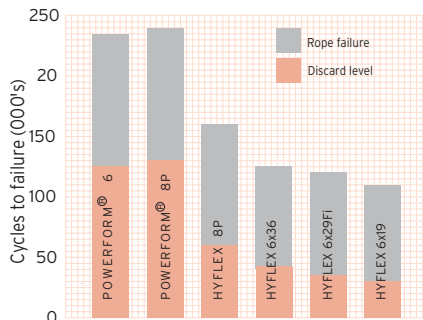

Note:
Our suffix is 'P'
Colour of plastication is indicated in orange

WIRE ROPE CHARACTERISTICS

PLASTICATED ROPE CHARACTERISTICS (Plastic Valley Filled)

- Full plastic impregnation
- Reduces wire contact stress & interstrand nicking
- Retains lubrication inside & does not require in-service lubrication
- Prevents ingress of solid abrasives & reduces internal corrosion
- Provides greater and better wear & abrasion resistance
- Minimizes bend stress over sheaves and increases fatigue life
- Ideally suitable for mining application

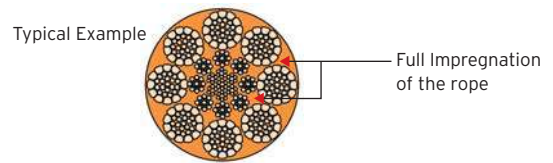

Comparison of service life (mining application)

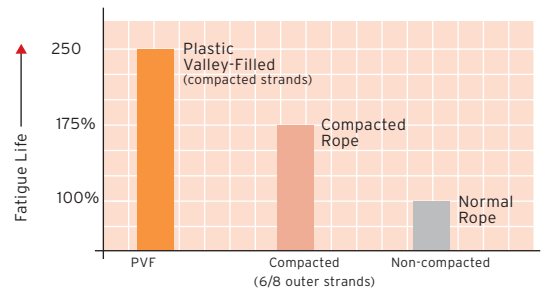

TYPES OF TYPICAL FAILURES

TERMINATION FAILURE

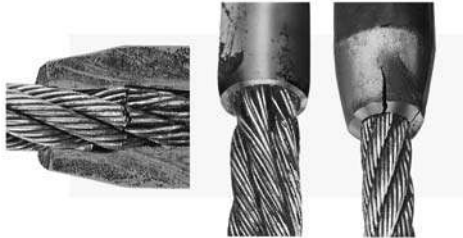

FATIGUE FAILURE

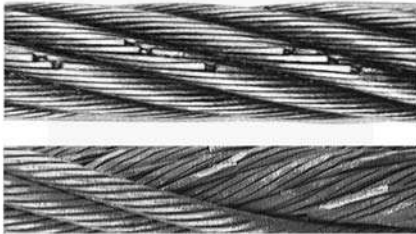

BIRDCAGE



TYPES OF TYPICAL FAILURES

SHOCK LOADING



ABRASION



THERMAL DAMAGE

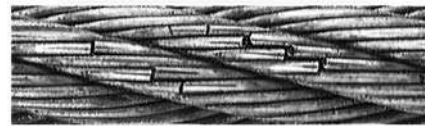

CORROSION

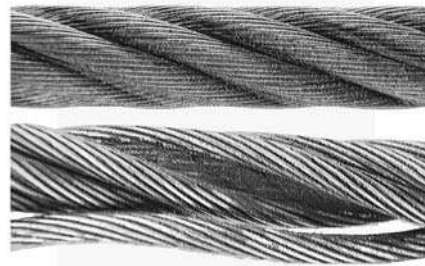

GENERAL DISCARD CRITERIA - CRANE ROPES

- Rope diameter reduction $>7\%$ of NRD, only due to external wear.
- Rope diameter reduction $>3\%$ of NRD for rotation resistant ropes and $>10\%$ for other ropes due reasons other than external wear.
- For single layer (6 and 8-strand) and parallel-closed ropes if number of visible broken wires exceed 4% of total load bearing wires in all outer stands of the rope, over a length 6d or 8% in 30d.
- For rotation resistant ropes if number of visible broken wires exceed 2 over a length 6d or 4 in 30d.
- Concentrated close group of broken wires in a length of 6d or in one strand.
- Wire break in the strand valley indicate internal rope deterioration requiring closer inspection of the rope, two or more valley breaks in 6xd requires discard.
- Broken wires at, adjacent to, the termination, require the termination to be remade by shortening the rope, otherwise the rope shall be discarded.
- Localised distortion, damage, crushing, kink, loop, birdcage formation.
- Localised core or strand protrusion.
- Localised rope diameter reduction or lay variation associated with waviness.
- Collapsed core or complete fracture of one strand.
- Sign of severe corrosion or pitting.
- Damage due to heat.

Note:

For discard of ropes other than crane wire ropes relevant code/standard should be referred.

The rope should be examined by a competent person who should always refer relevant code/recommendation/standard for deciding rope discard.

d/NRD implies nominal rope diameter

RECOMMENDED DO'S & DON'TS

DO'S

- Lubricate ropes with good quality acid free and moisture free lubricant.
- Regularly inspect the sheaves, rollers or pulleys - the life of a rope largely depends on their conditions.
- Inspect ropes and fittings/terminations periodically.

DON'TS

- Do not allow ropes in store to deteriorate
- Do not mishandle ropes when uncoiling or unreeling & allow kinks to form.
- Do not use Langs lay with a swivel
- Do not use a rope with too large groove diameter on drums and pulleys.
- Do not cut a rope without seizing.
- Do not use rope which is not sufficiently flexible for the size of drum or pulley.
- Do not load the rope beyond its safe working load. Reduction of safety factor may jeopardise not only rope, but also equipment, job and men.

Note:

Remember - Care in handling , installation, and careful inspection gives more life and enormous dividends.



ACCREDITATIONS AND CERTIFICATIONS



ACCREDITATION

BUREAU VERITAS Certification

USHA MARTIN LIMITED
usha martin

WIRE AND WIRE ROPES DIVISION
 HEAD OFFICE: PALADI, 180 FLOOR, 2/A, BRIDGEPARKS BAWANA, ADELPHI-750017, WEST BENGAL, INDIA
 This is a multi-site certificate, without site address listed in the certificate for compliance.

Bureau Veritas Certification certifies that the Management System of the above organization has been audited and found to be in accordance with the requirements of the management system standard detailed below.

Standard:
ISO 9001:2008

Scope of certification:
 ALL MANUFACTURING AND TRADING ACTIVITIES OF WIRE AND WIRE ROPES INCLUDING PLAN DRAWING, FABRICATION, FINISHING, TESTING AND SUPPLY OF WIRE AND WIRE ROPES. THIS INCLUDES THE FOLLOWING: WIRE AND WIRE ROPES FOR STEEL, STAINLESS STEEL, ALUMINUM AND COPPER. WIRE AND WIRE ROPES FOR CABLES AND WIRE ROPES FOR PULVERIZED FUELS. WIRE AND WIRE ROPES FOR CRAN CABLES AND WIRE ROPES FOR CONSTRUCTION. WIRE AND WIRE ROPES FOR CRAN CABLES AND WIRE ROPES FOR CONSTRUCTION. WIRE AND WIRE ROPES FOR CRAN CABLES AND WIRE ROPES FOR CONSTRUCTION.

Certification cycle start date: 03 April 2013
 Subject to the continued satisfactory operation of the organization's Management System, this certificate expires on: 02 April 2015
 Original certification date: 03 April 2010
 Version: 1 Revision date: 28 March 2013

Customer No: MC180224

Lead Auditor:
[Signature]
 Certification Authority
BUREAU VERITAS

ANAB

Further information regarding the scope of this certificate and the authority of the signatory, or the Bureau Veritas accreditation process, visit www.bv.com

Page 1 of 2

BUREAU VERITAS Certification

USHA MARTIN LIMITED
usha martin

WIRE AND WIRE ROPES DIVISION
 HEAD OFFICE: PALADI, 180 FLOOR, 2/A, BRIDGEPARKS BAWANA, ADELPHI-750017, WEST BENGAL, INDIA
 This is a multi-site certificate, without site address listed in the certificate for compliance.

Bureau Veritas Certification certifies that the Management System of the above organization has been audited and found to be in accordance with the requirements of the management system standard detailed below.

Standard:
ISO 9001:2008

Scope of certification:
 ALL MANUFACTURING AND TRADING ACTIVITIES OF WIRE AND WIRE ROPES INCLUDING PLAN DRAWING, FABRICATION, FINISHING, TESTING AND SUPPLY OF WIRE AND WIRE ROPES. THIS INCLUDES THE FOLLOWING: WIRE AND WIRE ROPES FOR STEEL, STAINLESS STEEL, ALUMINUM AND COPPER. WIRE AND WIRE ROPES FOR CABLES AND WIRE ROPES FOR PULVERIZED FUELS. WIRE AND WIRE ROPES FOR CRAN CABLES AND WIRE ROPES FOR CONSTRUCTION. WIRE AND WIRE ROPES FOR CRAN CABLES AND WIRE ROPES FOR CONSTRUCTION. WIRE AND WIRE ROPES FOR CRAN CABLES AND WIRE ROPES FOR CONSTRUCTION.

Certification cycle start date: 03 April 2013
 Subject to the continued satisfactory operation of the organization's Management System, this certificate expires on: 02 April 2015
 Original certification date: 03 April 2010
 Version: 1 Revision date: 28 March 2013

Customer No: MC180224

Lead Auditor:
[Signature]
 Certification Authority
BUREAU VERITAS

Further information regarding the scope of this certificate and the authority of the signatory, or the Bureau Veritas accreditation process, visit www.bv.com

Page 2 of 2

BUREAU VERITAS Certification

USHA MARTIN LIMITED
usha martin

WIRE AND WIRE ROPES DIVISION
 HEAD OFFICE: PALADI, 180 FLOOR, 2/A, BRIDGEPARKS BAWANA, ADELPHI-750017, WEST BENGAL, INDIA
 This is a multi-site certificate, without site address listed in the certificate for compliance.

Bureau Veritas Certification certifies that the Management System of the above organization has been audited and found to be in accordance with the requirements of the management system standard detailed below.

Standard:
ISO 9001:2008

Scope of certification:
 ALL MANUFACTURING AND TRADING ACTIVITIES OF WIRE AND WIRE ROPES INCLUDING PLAN DRAWING, FABRICATION, FINISHING, TESTING AND SUPPLY OF WIRE AND WIRE ROPES. THIS INCLUDES THE FOLLOWING: WIRE AND WIRE ROPES FOR STEEL, STAINLESS STEEL, ALUMINUM AND COPPER. WIRE AND WIRE ROPES FOR CABLES AND WIRE ROPES FOR PULVERIZED FUELS. WIRE AND WIRE ROPES FOR CRAN CABLES AND WIRE ROPES FOR CONSTRUCTION. WIRE AND WIRE ROPES FOR CRAN CABLES AND WIRE ROPES FOR CONSTRUCTION. WIRE AND WIRE ROPES FOR CRAN CABLES AND WIRE ROPES FOR CONSTRUCTION.

Certification cycle start date: 03 April 2013
 Subject to the continued satisfactory operation of the organization's Management System, this certificate expires on: 02 April 2015
 Original certification date: 03 April 2010
 Version: 1 Revision date: 28 March 2013

Customer No: MC180224

Lead Auditor:
[Signature]
 Certification Authority
BUREAU VERITAS

Further information regarding the scope of this certificate and the authority of the signatory, or the Bureau Veritas accreditation process, visit www.bv.com

Page 1 of 2

ACCREDITATION

Certificate of Authority to use the Official API Monogram
 License Number: SA-0017 ORIGINAL

The American Petroleum Institute hereby grants to
USHA MARTIN LIMITED
 Tatis/wai
 Ranchi, Jharkhand
 India

the right to use the Official API Monogram® on manufactured products under the conditions in the official publications of the American Petroleum Institute entitled API Spec Q1® and API Spec QA and in accordance with the provisions of the License Agreement.

In all cases where the Official API Monogram is applied, the API Monogram should be used in conjunction with this certificate number: SA-0017

The American Petroleum Institute reserves the right to revoke this authorization to use the Official API Monogram for any reason satisfactory to the board or directors of the American Petroleum Institute.

The scope of this license includes the following products: Bright or Drawn ; Galvanized Wire Rope; Mooring Wire Rope; Wire-Rope Strand.

GMS Exclusions: No Exclusions Identified as Applicable

Effective Date: NOVEMBER 4, 2012
 Expiration Date: NOVEMBER 4, 2015

To verify the authenticity of this license, go to www.api.org/certificateofauthority.

American Petroleum Institute
[Signature]
 Director of Global Industry Services



ACCREDITATION

ABS CERTIFICATE NUMBER: CC 2166478
 PORT OFFICE: KOLKATA, INDIA

Certificate of MANUFACTURING ASSESSMENT

This is to certify that: The Undersigned did evaluate the relevant manufacturing quality procedures for the type of products of the manufacturer:

Usha Martin Limited (Wire Ropes & Specialty Products Division)
 Plant at Ranchi, India

The methods of assuring and controlling quality during production as required by the ABS Rules or Guides for the product and the associated specifications or standards were verified to reflect the specific surveys, required by the Rules and Standards for the manufacture of:

STEEL WIRE ROPES

The manufacturer presented a sample or specimen of the product, representative of the "type" approved, to the undersigned, for the purpose of verifying that the "type" has been manufactured in conformance with the Manufacturer's Product Design Assessments.

This Certificate of Manufacturing Assessment is an evaluation of the manufacturer alone and is neither an approval nor a rejection of the product described above. Unless cancelled, expired or revoked, this certificate remains valid subject to annual audits.

Consult the ABS Type Approval website to confirm the continued validity of this certificate and the status of the particular products being manufactured.

ISSUE DATE: 28 June 2012 EXPIRATION DATE: 27 June 2017

SURVEYOR:  **S. P. CHOWDHURY**

FIRST ANNUAL ENDORSEMENT _____
 SECOND ANNUAL ENDORSEMENT _____
 THIRD ANNUAL ENDORSEMENT _____
 FOURTH ANNUAL ENDORSEMENT _____

Note: This Certificate constitutes compliance with one or more of the Rules, guides, standards or other criteria of American Bureau of Shipping and is issued solely for the use of the Bureau. It constitutes no warranty or other assurance. This Certificate is a statement of compliance with the applicable, best of practice, regulatory, statutory, industry and other standards to the satisfaction of the undersigned and is not a statement of approval or endorsement of the product. It is not a statement of approval or endorsement of the product. The validity, applicability and scope of this Certificate is limited to the specific products of American Bureau of Shipping as indicated on the certificate. American Bureau of Shipping is not responsible for the consequences of the use of this Certificate in any way other than that intended. American Bureau of Shipping is not responsible for the consequences of the use of this Certificate in any way other than that intended. American Bureau of Shipping is not responsible for the consequences of the use of this Certificate in any way other than that intended.

Rev 5 Page 1 of 2

ACCREDITATION



Certificate No: ACC/2011/0807/1

USHA MARTIN LIMITED
 Wire Ropes & Specialty Products Division
 Telephone No: 91 661 252 2522
 Ranchi
 Jharkhand
 India

Has been approved as a manufacturer in accordance with the requirements of
 Lloyd's Register for:

Steel Wire Ropes
 (Excludes HR steel wire)

This Approval is subject to compliance with the Rules for the Manufacture, Testing and Certification of Materials.

Lloyd's Register is to be notified of any change that may not give notice.

This Certificate is based on the above Manufacturer and is valid until:

Valid Until: 02 July 2014
 Date of Issue: 23 August 2012

Lloyd's Register

To: LR Certificate Ltd 11 Steel Wire Ropes

PROJECT: Material: SHE 42E DATE: 26 August 2012
 YSR REV: CC/2011/0807/1

USHA MARTIN LIMITED
 Wire Ropes & Specialty Products Division
 Telephone No: 91 661 252 2522
 Ranchi
 Jharkhand
 India

LIST OF APPROVED TESTING MACHINE				
TEST MACHINE	TYPE	SERIAL NUMBER	CAPACITY	UNIT
001	Universal	2111	100	kg
002	Universal	2148	100	kg
003	Universal	2149	100	kg
004	Universal	2150	100	kg
005	Universal	2151	100	kg
006	Universal	2152	100	kg
007	Universal	2153	100	kg
008	Universal	2154	100	kg
009	Universal	2155	100	kg
010	Universal	2156	100	kg
011	Universal	2157	100	kg
012	Universal	2158	100	kg
013	Universal	2159	100	kg
014	Universal	2160	100	kg
015	Universal	2161	100	kg
016	Universal	2162	100	kg
017	Universal	2163	100	kg
018	Universal	2164	100	kg
019	Universal	2165	100	kg
020	Universal	2166	100	kg
021	Universal	2167	100	kg
022	Universal	2168	100	kg
023	Universal	2169	100	kg
024	Universal	2170	100	kg
025	Universal	2171	100	kg
026	Universal	2172	100	kg
027	Universal	2173	100	kg
028	Universal	2174	100	kg
029	Universal	2175	100	kg
030	Universal	2176	100	kg
031	Universal	2177	100	kg
032	Universal	2178	100	kg
033	Universal	2179	100	kg
034	Universal	2180	100	kg
035	Universal	2181	100	kg
036	Universal	2182	100	kg
037	Universal	2183	100	kg
038	Universal	2184	100	kg
039	Universal	2185	100	kg
040	Universal	2186	100	kg
041	Universal	2187	100	kg
042	Universal	2188	100	kg
043	Universal	2189	100	kg
044	Universal	2190	100	kg
045	Universal	2191	100	kg
046	Universal	2192	100	kg
047	Universal	2193	100	kg
048	Universal	2194	100	kg
049	Universal	2195	100	kg
050	Universal	2196	100	kg
051	Universal	2197	100	kg
052	Universal	2198	100	kg
053	Universal	2199	100	kg
054	Universal	2200	100	kg
055	Universal	2201	100	kg
056	Universal	2202	100	kg
057	Universal	2203	100	kg
058	Universal	2204	100	kg
059	Universal	2205	100	kg
060	Universal	2206	100	kg
061	Universal	2207	100	kg
062	Universal	2208	100	kg
063	Universal	2209	100	kg
064	Universal	2210	100	kg
065	Universal	2211	100	kg
066	Universal	2212	100	kg
067	Universal	2213	100	kg
068	Universal	2214	100	kg
069	Universal	2215	100	kg
070	Universal	2216	100	kg
071	Universal	2217	100	kg
072	Universal	2218	100	kg
073	Universal	2219	100	kg
074	Universal	2220	100	kg
075	Universal	2221	100	kg
076	Universal	2222	100	kg
077	Universal	2223	100	kg
078	Universal	2224	100	kg
079	Universal	2225	100	kg
080	Universal	2226	100	kg
081	Universal	2227	100	kg
082	Universal	2228	100	kg
083	Universal	2229	100	kg
084	Universal	2230	100	kg
085	Universal	2231	100	kg
086	Universal	2232	100	kg
087	Universal	2233	100	kg
088	Universal	2234	100	kg
089	Universal	2235	100	kg
090	Universal	2236	100	kg
091	Universal	2237	100	kg
092	Universal	2238	100	kg
093	Universal	2239	100	kg
094	Universal	2240	100	kg
095	Universal	2241	100	kg
096	Universal	2242	100	kg
097	Universal	2243	100	kg
098	Universal	2244	100	kg
099	Universal	2245	100	kg
100	Universal	2246	100	kg

Steel Wire Ropes
 Maximum 100.00 mm diameter



ACCREDITATION



ACCREDITATION

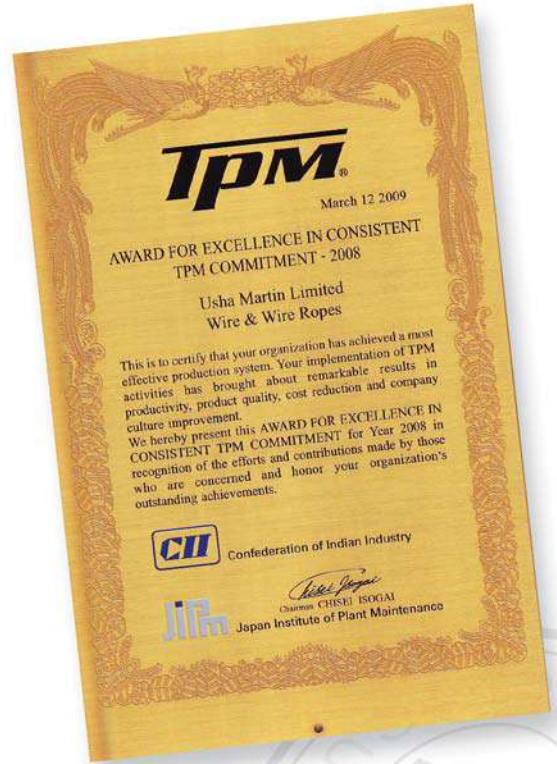

CONSTRUCTION OF WIRE ROPES



CONSTRUCTION OF WIRE ROPES



SPIRAL STRANDS
Page # 62

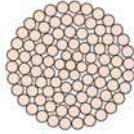

SPIRAL STRANDS
Page # 63

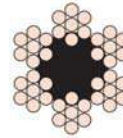

ROUND STRAND 6/7 (6/1)
(Aerial Haulage) Page # 70

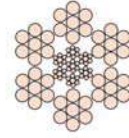

ROUND STRAND 6/7 (6/1)
Page # 71

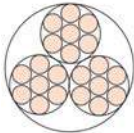

3 STRAND SAFETY BARRIERS
3 x 7 (6-1) Page # 64

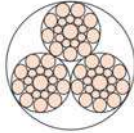

3 STRAND TRAWLER ROPE
Page # 65

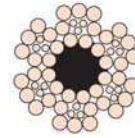

FLATTENED STRAND
6x8 (7/▲) & 6x9 (8/▲) FS
Page # 72

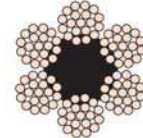

ROUND STRAND
6/19M (12/6-1) Page # 73

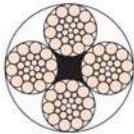

4 STRAND TRAWLER ROPE
4/26SW (10-5+5-5-1) Page # 66



HYFLEX 4
Page # 67

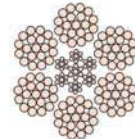

ROUND STRAND
6/19M (12/6-1) Page # 74

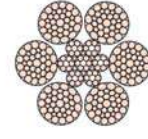

TITAN ANCHOR MOORING
& PENNANT ROPES Page # 75

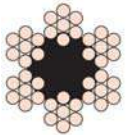

ROUND STRAND 6/7 (6/1)
Page # 68



ROUND STRAND 6/7 (6/1)
(Man - Riding Haulage) Page # 69

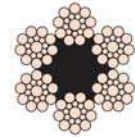

ROUND STRAND
6/19S (9-9-1) Page # 76



HOIST & COMPENSATING ROPE
6/19 Classification Page # 77



CONSTRUCTION OF WIRE ROPES



ROUND STRAND
6/19S (9-9-1) Page # 78



TITAN DRILLING LINES
6 x 19 class rope with CWR (IWRC)
(Bright) Page # 79

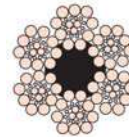

FLATTENED STRAND 6x22 (9/12-▲)
& 6x25 (12/12-▲) FS Page # 86

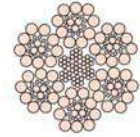

FLATTENED STRAND 6x22 (9/12-▲)
& 6x25 (12/12-▲) FS Page # 87

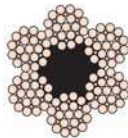

ROUND STRAND
6/19F (12-6F+6-1) Page # 80

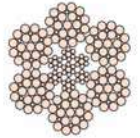

ROUND STRAND
6/19F (12-6F+6-1) Page # 81



SHIPPING ROPE
6x24 (15/9/Fibre) Page # 88



FISHING ROPE 6 x 24 (15/9-FC)
& 6 x 24S (12-12-FC) Page # 89



HYFLEX 6 x 19
Page # 82



POWERFORM 6/6P
Page # 83

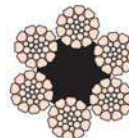

FISHING ROPE 6 x 26WS
(10-5+5-5-1) COMPACTED
Page # 90



ROUND STRAND
6/29F (14-7F+7-1) Page # 91

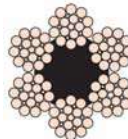

ROUND STRAND
6 x 21F (10-5F-5-1) Page # 84



ROUND STRAND
6 x 21F (10-5F-5-1) Page # 85



ROUND STRAND
6/29F (14-7F+7-1) Page # 92



HYFLEX 6/29Fi
Page # 93



CONSTRUCTION OF WIRE ROPES



ROUND STRAND
6/36SW (14-7+7-7-1) Page # 94



ROUND STRAND
6/36SW (14-7+7-7-1) Page # 95



CONVEYOR CORD 7 X 7
Page # 102

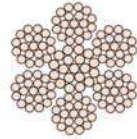

CONVEYOR CORD 7 X 19
Page # 103



TITAN RISER TENSIONER ROPES
6 x 37 class rope with CWR (IWRC)
Page # 96

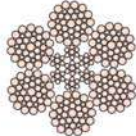

HYFLEX 6 x 36
Page # 97



ROUND STRAND BRIDGE ROPES
Page # 104

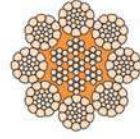

POWERFORM 8/8P
Page # 105

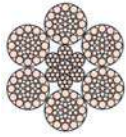

SPECIAL MINING ROPES
MINESFLEX 6 Page # 98



ROUND STRAND
6/37M (18/12/6-1) Page # 99

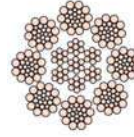

HYFLEX 8
Page # 106

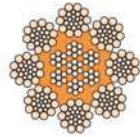

HYFLEX 8P
Page # 106

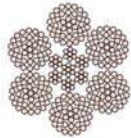

ROUND STRAND
6/37M (18/12/6-1) Page # 100



SHIPPING ROPE
6 x 37 (18/12/6/1) Page # 101

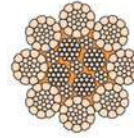

POWERFORM[®] 8PC
Page # 107



SPECIAL MINING ROPES
MINESFLEX 8 Page # 108



CONSTRUCTION OF WIRE ROPES



SPECIAL MINING ROPES
MINESFORM 8 PVF Page # 109

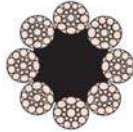

HOIST & COMPENSATING ROPE
8 x 19 S (9-9-1) Page # 110

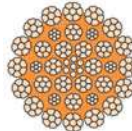

POWERFORM 35P
Page # 115



HYFLEX 35
Page # 116



HOIST & COMPENSATING ROPE
Page # 111



GOVERNOR ROPES
6/25F (12-6+6F-1) Page # 112



HYFLEX 35P
Page # 116



LOCKED COIL TRACK ROPES &
STRUCTURAL ROPES Page # 117



GOVERNOR ROPES
8/19S (9-9-1) Page # 112

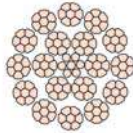

POWERFORM 18
Page # 113

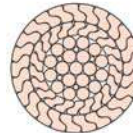

LOCKED COIL TRACK ROPES &
STRUCTURAL ROPE Page # 118

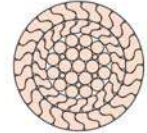

LOCKED COIL TRACK ROPES &
STRUCTURAL ROPE Page # 119



HYFLEX 18
Page # 114

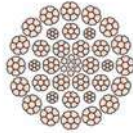

POWERFORM 35
Page # 115

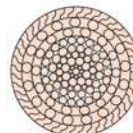

LOCKED COIL WINDING ROPES
Page # 120

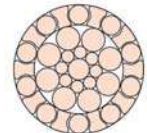

LOCKED COIL GUIDE ROPES
Page # 121



APPLICATION WISE ROPE LIST



GENERAL ENGINEERING

Construction	Page ref.
6 x 7 & 7 x 7	68, 71
6 x 19M	73, 74
6 x 19F	80, 81
6 x 19S	76, 78
6 x 29F	91, 92
6 x 36SW	94, 95
6 x 37M	99, 100

OIL FIELD

Construction	Page ref.
TITAN Anchor Mooring	75
TITAN Drilling Lines	79
TITAN Riser Tensioner	96
35 x 7 for cranes	116

CRANE

Construction	Page ref.
Powerform 35/35P	115
Hyflex 35/35P	116
Powerform 18	113
Hyflex 18	114
Powerform 6/6P	83
Powerform 8/8P	105
Hyflex 8/8P	106
Powerform 8PC	107
Hyflex 4	67
Hyflex 6 x 36	97
Hyflex 6 x 19	82
Hyflex 6 x 29F	93

FISHING

Construction	Page ref.
3-Strand	65
4-Strand	66
6 x 7	68
6 x 19S	76
6 x 19M	73
6 x 21F	84
6 x 24 (15/9/FC)	89
6 x 24S (12/12/FC)	89
6 x 26WS compacted	90



MINING

Construction	Page ref.
6 x 7 Winding	69
6 x 7 Haulage	68
6 x 8FS	72
6 x 22 / 6 x 25FS	86, 87
Locked Coil Winding	120
Half-locked Guide	121
6 x 36SW	95
Minesflex 6	98
Minesflex 8	108
Minesform 8PVF	109

AERIAL ROPEWAY

Construction	Page ref.
6 x 7 Haulage	70
6 x 19S	76
6 x 8FS	72
Full Locked Coil Track	117 - 119

SHIPPING

Construction	Page ref.
6 x 37	101
6 x 24	88

ELEVATOR

Construction	Page ref.
6 x 19F (CFN)	77
8 x 19S (CFN)	110
8 x 19S + IWRC (8 x 7 + CF)	111
Governor Rope	112

STRUCTURAL

Construction	Page ref.
3 x 7 Safety Barriers	64
7 x 37	104
Spiral Strand	62, 63
Locked Coil	117 - 119

CONVEYOR CORDS

Construction	Page ref.
7 x 7	102
7 x 19	103



**CONSOLIDATED
READY
RECKONER**



CONSOLIDATED READY RECKONER

Rope Description	Gen. Engg.	Spl. Crane	Oil Field	Fishing	Structural	Mining	Aerial	Elevator	Shipping	Page No.
1x19-1x547					■					62, 63
3x7					■					64
3x19S-3x31SW				■						65
4x26SW				■						66
Hyflex 4		■								67
6x7FMC	■			■		■	■			68 - 70
6x7 Steel	■					■				71
6x8FS						■				72
6x19M FMC	■			■						73
6x19M Steel	■		■	■						74
6x19S FMC	■		■	■		■	■			76, 77
6x19S Steel	■							■		78, 79
6x19F FMC	■							■		80, 112
6x19F Steel	■									81
Hyflex 6x19		■								82
Powerform 6/6P		■								83
6x21F	■							■		84, 85
6x22-6x25FS						■		■		86, 87
6x24				■					■	88, 89
6x26SW				■						90
6x29F	■									91, 92
Hyflex 6/29Fi		■								93
6x36SW FMC	■		■							94

Rope Description	Gen. Engg.	Spl. Crane	Oil Field	Fishing	Structural	Mining	Aerial	Elevator	Shipping	Page No.
6x36SW Steel	■		■				■			75, 95
Hyflex 6x36		■								97
Minesflex 6							■			98
6x37M FMC	■								■	96, 99, 100
6x37M Steel	■									101
7x7		■								102
7x19		■								103
7x37						■				104
Powerform 8/8P		■								105
Hyflex 8/8P		■								106
Powerform 8PC		■								107
Minesflex 8							■			108
Minesflex 8PVF							■			109
8x19S								■		110-112
Powerform 18		■								113
Hyflex 18		■								114
Powerform 35/35P		■								115
Hyflex 35/35P		■								116
LCTR & LCBR						■	■			117-119
LCWR							■			120
LCGR							■			121

Note:
Conveyor Cords only.



ROPE DETAILS



SPIRAL STRANDS



CONSTR.	NOMINAL ROPE DIA	APPROX. MASS	MINIMUM BREAKING FORCE	
			1570 N/mm ²	1770 N/mm ²
	mm	Kg./100m	kN	kN
1x19	11	61.1	99.9	113
	13	85.3	140	157
	14.5	106	174	196
	16	129	211	238
	19	182	298	336
1x37	22	244	390	439
	26	341	544	614
	29	425	677	763
	32	517	824	930
1x61	35	619	986	
	32	517	823	928
	35	619	985	1110
	38	729	1160	1310
	42	891	1420	
	45	1023	1630	

- Special requirements on breaking forces can also be met.
- Spiral Strands may be provided conforming to various relevant national and international standards to suit customer needs.
- Spiral Strands can also be provided in sizes and constructions not included in the table above.

SPIRAL STRANDS

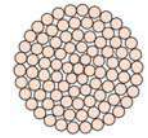

CONSTR.	NOMINAL ROPE DIA	APPROX. MASS	MINIMUM BREAKING FORCE	
			1570 N/mm ²	1770 N/mm ²
	mm	Kg./100m	kN	kN
1 x 91	40	808	1280	1450
	42	891	1410	1590
	45	1020	1620	1830
	48	1160	1850	2080
	51	1310	2090	2350
	54	1470	2340	2640
1 x 127 ... 547	57	1640	2610	2940
	60	1820	2890	3250
	64	2070	3280	3700
	66	2200	3490	3940
	68	2340	3710	4180
	71	2550	4040	4560
	74	2770	4390	4950
	77	2990	4750	5360
	80	3230	5130	5790
	84	3560	5660	6380
87	3820	6070	6840	
90	4090	6500	7320	

- Special requirements on breaking forces can also be met.
- Spiral Strands may be provided conforming to various relevant national and international standards to suit customer needs.
- Spiral Strands can also be provided in sizes and constructions not included in the table above.



3 STRAND SAFETY BARRIERS 3 x 7 (6-1)

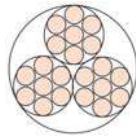

NOM. ROPE DIA	APPROX. MASS	MINIMUM BREAKING FORCE
mm	Kg./100m	kN
19	121.00	173.6

Supplied as Pre-stretched

Lay - Right Hand

Coating - Galvanised Class - A (normal coating mass of 230 gm/m²)

May also be supplied with coating mass of 400 gm/m².

Typical Applications

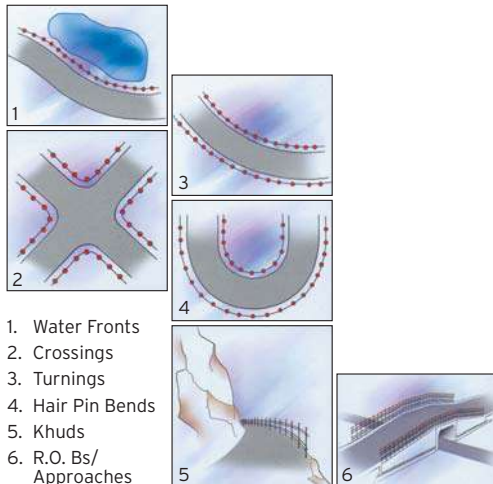

1. Water Fronts
2. Crossings
3. Turnings
4. Hair Pin Bends
5. Khuds
6. R.O. Bs/
Approaches

3 STRAND TRAWLER ROPE

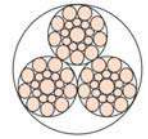

NOM. ROPE DIA	APPROX. MASS Kg./100m	MINIMUM BREAKING FORCE
		1570 N/mm ²
mm		kN
12	52.6	84
14	72.2	115
16	91.8	146
18	115	185
20	147	230
22	175	276
24	211	329
26	241	386
28	281	447
30	322	513
32	366	573

Note:

The following are the constructions available for each diameter.
Diameter tolerance -1, +4%. All ropes are galvanised.

Diameter	Constructions
12 mm	3 x 19 S
14 mm	3 x 19 S
16 mm	3 x 19S, 3 x 26SW & 3 x 31SW
18 mm	3 x 19S, 3 x 26SW & 3 x 31SW
20 mm	3 x 19S, 3 x 26SW & 3 x 31SW
22 mm	3 x 19S, 3 x 26SW & 3 x 31SW
24 mm	3 x 19S, 3 x 26SW & 3 x 31SW
26 mm	3 x 26SW & 3 x 31SW
28 mm	3 x 26SW & 3 x 31SW
30 mm	3 x 26SW & 3 x 31SW
32 mm	3 x 26SW & 3 x 31SW



4 STRAND TRAWLER ROPE 4/26SW (10-5+5-5-1)

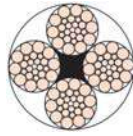

NOM. ROPE DIA	APPROX. MASS Kg./100m	MINIMUM BREAKING FORCE	
		1570 N/mm ²	
mm	FIBRE	kN	
12	56.9	82.1	
14	77.4	112	
16	100	146	
18	126	185	
20	156	228	
22	188	275	
24	224	328	
26	263	385	
28	305	446	
30	350	512	
32	398	583	

Note:

All intermediate sizes are also available.
All Ropes are galvanised.

HYFLEX 4

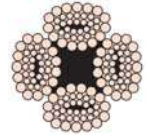

NOM. ROPE DIA	NOM. ROPE DIA	APPROX. MASS	MINIMUM BREAKING FORCE	
			1770 N/mm ²	1960 N/mm ²
mm	in	Kg./100m	kN	kN
10		44.8	64.0	69.4
12		65.4	92.3	99.9
14		88.8	125.5	136.5
16	5/8	117	164.5	177.4
18		149	207.5	224.5
19	3/4	167	231.5	250.5
20		183	256.5	277.5
22		214	310	336
	7/8	218	317	343
24		253	369	400
25		275	399	432
	1	284	413	448
26		298	433	469
28		346	502	544
30		398	576	624
32	1.1/4	456	656	689
34		512	740	802
36		574	830	898
38	1.1/2	640	924	1002
40		709	1002	1082
42		782	1102	1192
44		859	1212	1312
45		898	1272	1372

Note:

Rope Sizes and Breaking Force not shown in the standard table, may be available on request and prior confirmation.



ROUND STRAND 6/7 (6/1)

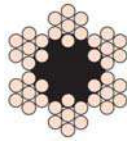

NOM. ROPE DIA	APPROX. MASS Kg./100m	MINIMUM BREAKING FORCE		
		1570 N/mm ²	1770 N/mm ²	1960 N/mm ²
mm	FIBRE CORE	kN	kN	kN
3	3.22	4.7	5.3	5.9
4	5.72	8.3	9.4	10.4
5	8.94	13.0	14.7	16
6	12.9	18.8	21.1	23
8	22.9	33.4	37.6	42
9	28.9	42.2	47.6	53
10	35.7	52.2	58.8	65
11	43.2	63.1	71.1	79
12	51.5	75.1	84.7	94
13	60.4	88.1	99.4	110
14	70.1	102	115	127
16	91.5	134	151	167
18	116	169	191	212
20	143	209	235	260
22	173	252	285	316
24	206	300	339	375
26	242	353	397	440
28	280	409	461	510
32	366	534	602	667
36	463	676	762	844
40	572	835	941	1042

Note:

All intermediate sizes are also available

ROUND STRAND 6/7 (6/1) (Man-Riding Haulage)

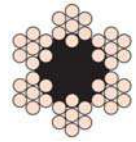

NOM. ROPE DIA	APPROX. MASS Kg./100m	MINIMUM BREAKING FORCE		
		1570 N/mm ²	1770 N/mm ²	1960 N/mm ²
mm	FIBRE CORE	kN	kN	kN
13	60.4	88.1	99.4	110
14	70.1	102	115	128
16	91.5	134	151	167
18	116	169	191	211
19	129	188	212	235
20	143	209	235	260
21	158	230	259	287
22	173	252	285	315
24	206	300	339	375
25	223	326	367	407
26	242	353	397	440
27	261	380	429	475
28	280	409	461	510
29	301	439	495	548

Note:

All intermediate sizes are also available



ROUND STRAND 6/7 (6/1) (Aerial Haulage)

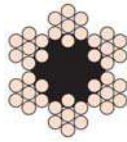

NOM. ROPE DIA	APPROX. MASS Kg./100m	MINIMUM BREAKING FORCE		
		1420 N/mm ²	1570 N/mm ²	1770 N/mm ²
mm	FIBRE CORE	kN	kN	kN
8	22.9	30	33	38
10	35.7	47	52	59
12	51.5	68	75	85
14	70.1	92	102	115
16	91.5	121	134	151
18	116	153	169	191
20	143	189	209	235
22	173	228	252	285
26	242	319	353	397
28	280	370	409	461
32	366	483	534	602
36	463	611	676	762
38	516	681	753	849
40	572	755	834	941

Note:

All intermediate sizes are also available

ROUND STRAND 6/7 (6/1)

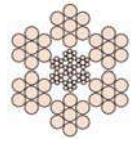

NOM. ROPE DIA	APPROX. MASS Kg./100m	MINIMUM BREAKING FORCE		
		1570 N/mm ²	1770 N/mm ²	1960 N/mm ²
mm	STEEL CORE	kN	kN	kN
3	3.54	5.1	5.7	6.3
4	6.29	9.0	10.2	11.3
5	9.83	14.0	15.9	17.6
6	14.2	20.0	22.9	25.0
8	25.2	36.1	40.6	45.0
9	31.8	45.6	51.4	57.0
10	39.3	56.3	63.5	70.0
11	47.5	68.2	76.8	85.0
12	56.7	81.1	91.5	101
13	66.4	95.2	107	118
14	77.1	110	124	137
16	101	144	163	180
18	128	183	206	228
20	157	225	254	281
22	190	273	307	340
24	227	324	366	405
26	266	381	429	475
28	308	441	498	551
32	403	577	650	720
36	509	730	823	911
40	629	901	1010	1118

Note:

All intermediate sizes are also available



FLATTENED STRAND

6 x 8(7/▲)
& 6 x 9 (8/▲)FS

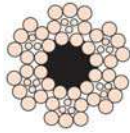

NOM. ROPE DIA	APPROX. MASS Kg./100m	MINIMUM BREAKING FORCE		
		1420 N/mm ²	1570 N/mm ²	1770 N/mm ²
mm	FIBRE CORE	kN	kN	kN
13	69.30	87	96	108
14	80.40	101	111	126
16	105.00	132	145	164
18	133.00	167	184	208
19	148.00	186	205	231
20	164.00	206	227	256
22	198.00	249	275	310
24	236.00	296	327	369
25	256.00	321	355	400
26	277.00	347	384	433
28	321.00	403	446	502
29	345.00	432	478	539
32	420.00	526	582	656
33	446.00	560	619	698
35	502.00	630	696	785

Note:

All intermediate sizes are also available

ROUND STRAND

6/19M (12/6-1)



NOM. ROPE DIA	APPROX. MASS Kg./100m	MINIMUM BREAKING FORCE		
		1570 N/mm ²	1770 N/mm ²	1960 N/mm ²
mm	FIBRE CORE	kN	kN	kN
3	3.11	4.3	4.9	5.4
4	5.54	7.7	8.7	9.6
6	12.50	17	20	22
8	22.10	31	35	39
10	34.60	48	54	60
12	49.80	69	78	87
12.7	56.40	77	87	97
14	67.80	95	107	118
16	88.60	124	139	154
18	112.00	156	176	195
19	125.00	174	196	217
20	138.00	193	218	241
22	167.00	234	263	292
24	199.00	278	313	347
25	215.92	301	340	376
26	234.00	326	368	407
28	271.00	378	426	472
30	311.00	434	490	542
32	354.00	494	557	617
34	400.00	557	629	697
36	448.00	625	705	781
38	500.00	697	785	870
40	554.00	772	870	964

Note:

All intermediate sizes are also available



ROUND STRAND

6/19M (12/6-1)



NOM. ROPE DIA	APPROX. MASS Kg./100m	MINIMUM BREAKING FORCE		
		1570 N/mm ²	1770 N/mm ²	1960 N/mm ²
mm	STEEL CORE	kN	kN	kN
3	3.42	4.6	5.3	5.9
4	6.09	8.3	9.4	10.4
6	13.8	19	21	23
8	24.3	33	38	42
10	38.1	52	59	65
12	54.8	75	85	94
12.7	63.5	84	95	105
14	74.6	102	115	128
16	97.4	133	150	167
18	123	169	190	211
19	137	188	212	235
20	152	208	235	260
22	184	252	284	315
24	219	300	338	375
25	238	325	367	407
26	257	352	397	440
28	298	409	461	510
30	342	469	529	585
32	390	534	602	666
34	440	602	680	752
36	493	675	761	843
38	550	752	848	939
40	609	834	940	1041

Note:

All intermediate sizes are also available

TITAN ANCHOR MOORING

6 x 19 and 6 x 37 class rope with CWR (IWRC) Bright or Drawn Galvanised (RRL)

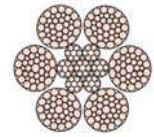

NOMINAL ROPE DIA	APPROX. MASS (Kg/100m)	MINIMUM BREAKING FORCE (F _{min})		
		EEIPS	SUPER TITAN	TITAN MAX
inch	mm	kN	kN	kN
1-1/2	38	619	1110	
1-5/8	42	726	1300	
1-3/4	45	844	1500	
1-7/8	48	967	1710	
2.0	52	1100	1930	2222
2-1/8	54	1240	2160	2492
2-1/4	58	1390	2420	2761
2-3/8	60	1550	2690	3063
2-1/2	64	1730	2950	3365
2-5/8	67	1900	3240	3689
2-3/4	71	2080	3530	4025
2-7/8	74	2280	3840	4382
3.0	77	2470	4160	4751
3-1/8	80	2680	4490	5120
3-1/4	83	2900	4830	5512
3-3/8	87	3130	5180	5903
3-1/2	90	3340	5520	6294
3-5/8	92	3540	5860	6662
3-3/4	96	3870	6270	7029
4.0	103	4400	6340	7908
4-1/8	105	4680	6700	8119
4-1/4	108	4970	7110	8928
4-1/2	115	5570	7900	9845
5.0	127	6990	9590	11000

** Approx Mass values in table are valid for EEIPS grade only. Rope Mass for Supertitan & Titan Max is available on request and prior confirmation.

TYPICAL EXAMPLE

Class	Construction		Nominal Rope Dia	
	Rope	Strand	Inch.	mm
6 x 19	6 x 25 F	12-6F-6-1	- 2.1/2	38 - 64
6 x 37	6 x 31 WS	12-6+6-6-1	- 2.1/2	38 - 64
	6 x 36 WS	14-7+7-7-1	- 3	38 - 77
	6 x 41 WS	16-8+8-8-1	- 3.1/2	52 - 90
	6 x 49 SWS	16-8+8-8-8-1	- 3.1/2	52 - 90
	6 x 46(52) WS	18-9+9-9/6-1	- 4.1/2	77 - 115



ROUND STRAND

6/19S (9-9-1)



NOM. ROPE DIA	APPROX. MASS Kg./100m	MINIMUM BREAKING FORCE		
		1570 N/mm ²	1770 N/mm ²	1960 N/mm ²
mm	FIBRE CORE	kN	kN	kN
6	13.4	-	21.1	-
8	23.8	33.2	37.5	42
10	37.3	52	59	65
12	53.7	75	84	93
13	63.0	88	99	110
14	73.0	102	115	127
16	95.4	133	150	166
18	121	168	190	210
19	135	188	211	234
20	149	208	234	260
22	180	252	284	314
24	215	299	337	374
25	233	325	366	406
26	252	351	396	439
28	292	407	459	509
30	335	468	527	584
32	382	532	600	664
34	431	600	677	750
36	483	673	759	841
38	538	750	846	937
40	596	831	937	1038
42	657	917	1033	1144
44	721	1006	1134	1256
46	788	1099	1240	1373
48	858	1197	1350	1495
50	932	1299	1465	1622
51	970	1351	1524	1688

Note:

All intermediate sizes are also available

HOIST & COMPENSATING ROPE

6/19 Classification

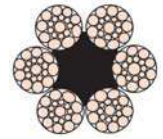

NOM. ROPE DIA	APPROX. MASS Kg./100m	MINIMUM BREAKING FORCE (KN)
		1570 or 1370 / 1770 N/mm ²
mm	FIBRE CORE (CFN)	
612.5	17.80	22.40
6.5	15.3	
822.1	31.70	
929.2	40.20	
1035.2	49.50	
1142.6	59.70	
1250	71.30	
1360	83.70	
1471	97.00	
1690	127.00	
19127	179.00	
22170	240.00	



ROUND STRAND

6/19S (9-9-1)

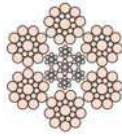

NOM. ROPE DIA	APPROX. MASS Kg./100m	MINIMUM BREAKING FORCE		
		1570 N/mm ²	1770 N/mm ²	1960 N/mm ²
mm	STEEL CORE	kN	kN	kN
6	15.0	-	22.8	-
8	26.2	36.0	40.0	45.0
10	41.0	56.0	63.0	70.0
12	59.0	81.0	91.0	101
13	69.3	95.0	107	118
14	80.3	110	124	137
16	105	144	162	179
18	133	182	205	227
19	149	203	228	253
20	164	224	253	280
22	198	272	306	339
24	237	323	364	403
25	256	350	396	438
26	277	379	428	474
28	321	440	496	549
30	368	505	570	630
32	420	575	648	717
34	474	648	731	810
36	531	727	820	908
38	592	810	913	1012
40	656	898	1012	1121
42	721	990	1116	1236
44	792	1086	1225	1356
46	865	1187	1339	1482
48	942	1293	1458	1614
50	1022	1403	1582	1751
51	1064	1460	1646	1822

Note:

All intermediate sizes are also available

TITAN DRILLING LINES

6 x 19 class rope
with CWR (IWRC) (Bright)



NOMINAL ROPE DIA		APPROX. MASS Kg./100m	MINIMUM BREAKING FORCE	
Inch.	mm		EIPS	EEIPS
			kN	kN
3/4	19	155	262	288
7/8	22	211	354	389
1.0	26	275	460	506
1 - 1/8	29	348	568	636
1 - 1/4	32	430	711	782
1 - 3/8	35	521	854	943
1 - 1/2	38	619	1010	1112
1 - 5/8	42	726	1170	1300
1 - 3/4	45	844	1360	1500
1 - 7/8	48	967	1550	1710
2.0	52	1100	1760	1930

TYPICAL EXAMPLE

Class	Construction		Nominal Rope Dia	
	Rope	Strand	Inch.	mm
6 x 19	6 x 19 S	9-9-1	3/4 - 2	19 - 52
	6 x 26 WS	10-5+5-5-1	3/4 - 2	19 - 52



ROUND STRAND

6/19F (12-6F+6-1)



NOM. ROPE DIA	APPROX. MASS Kg./100m	MINIMUM BREAKING FORCE		
		1570 N/mm ²	1770 N/mm ²	1960 N/mm ²
mm	FIBRE CORE	kN	kN	kN
8	24.3	34	38	42
10	38.0	53	60	66
12	54.7	76	86	95
13	64.3	90	101	112
14	74.5	104	117	130
16	97.3	136	153	169
18	123	172	194	214
19	137	191	216	239
20	152	212	239	265
22	184	257	289	320
24	219	305	344	381
26	257	358	404	447
28	298	416	469	519
32	389	543	612	678
34	439	613	691	765
36	493	687	775	858
38	549	766	863	956
40	608	848	956	1059
44	736	1026	1157	1281
46	804	1122	1265	1401
48	876	1222	1377	1525
52	1028	1434	1616	1790
58	1279	1784	2011	2227
60	1369	1909	2152	2383
64	1557	2172	2448	2711

Note:

All intermediate sizes are also available

ROUND STRAND

6/19F (12-6F+6-1)

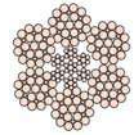

NOM. ROPE DIA	APPROX. MASS Kg./100m	MINIMUM BREAKING FORCE		
		1570 N/mm ²	1770 N/mm ²	1960 N/mm ²
mm	STEEL CORE	kN	kN	kN
8	26.7	37	41	46
10	41.8	57	65	71
12	60.2	82	93	103
13	70.7	97	109	121
14	82.0	112	127	140
16	107	147	165	183
18	135	186	209	232
19	151	206	233	258
20	167	229	258	286
22	202	277	312	346
24	241	330	372	412
26	283	387	436	483
28	328	449	506	560
32	428	586	661	732
34	484	662	746	826
36	542	742	837	926
38	604	827	932	1032
40	669	916	1030	1144
44	810	1110	1250	1384
46	885	1212	1366	1513
48	964	1319	1487	1647
52	1131	1448	1745	1933
58	1407	1927	2172	2403
60	1506	2061	2324	2573
64	1714	2345	2644	2928

Note:

All intermediate sizes are also available



HYFLEX 6X19

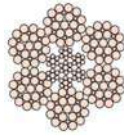

NOM. ROPE DIA	NOM. ROPE DIA	APPROX. MASS	MINIMUM BREAKING FORCE	
			1770 N/mm ²	1960 N/mm ²
mm	in	Kg./100m	kN	kN
6		14.3	22.7	25.1
8		25.5	40.3	44.7
10		39.8	63.0	69.8
12		57.3	90.7	101
	1/2	64.2	102	113
13		67.3	107	118
14		78.0	124	137
16	5/8	102	161	179
18		129	204	226
20		159	252	279
22		193	305	338
	7/8	197	311	345
24	15/16	229	363	402
	1	257	407	450
26		269	426	472
28		312	494	547
32	1.1/4	408	645	715
36		516	817	904
40		637	1010	1120
44		771	1220	1350
48	1.7/8	917	1450	1610
52		1076	1700	1890
56		1248	1980	2190
60		1433	2270	2510

Note:

Rope Sizes and Breaking Force not shown in the standard table, may be available on request and prior confirmation.

POWERFORM 6/6P

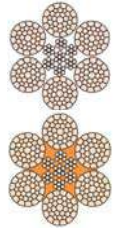

NOM. ROPE DIA	NOM. ROPE DIA	APPROX. MASS	MINIMUM BREAKING FORCE	
			1770 N/mm ²	1960 N/mm ²
mm	in	Kg./100m	kN	kN
10		46.4	69.5	85.7
11		56.1	83.8	98.6
	1/2	74.8	113	140
13		78.4	118	147
14		90.9	137	170
16	5/8	119	178	218
18		150	225	276
19	3/4	168	251	304
20		186	278	335
22		225	336	400
	7/8	229	343	408
24		267	400	489
	1	299	449	552
28		364	545	657
32	1-1/4	475	712	846
34		518	804	916
36		581	901	1065
38	1-1/2	647	1004	1165
40		717	1112	1295
46		948	1362	1665
48		1032	1483	1885
50		1120	1609	1975
52		1211	1741	2135
56		1405	2019	2475
58		1507	2166	2650
60		1613	2317	2810

Note:

'P' signifies full plastic impregnation of the steel core

POWERFORM 6P is available only for 16 mm & above. Rope Sizes and MBL not shown above are also available on request and prior confirmation.

Mass per unit length of POWERFORM 6P increases by approx. 3%



ROUND STRAND

6 x 21F (10-5F-5-1)



NOM. ROPE DIA	APPROX. MASS Kg./100m	MINIMUM BREAKING FORCE	
		1570 N/mm ²	1770 N/mm ²
mm	FIBRE CORE	kN	kN
8.00	24.3	34	38
9.00	30.8	43	48
10.00	38	53	60
11.00	46	64	72
12.00	54.7	76	86
13.00	64.3	90	101
14.00	74.5	104	117
16.00	97.3	136	153
18.00	123	172	194
19.00	137	191	216
20.00	152	212	239
22.00	184	257	289
24.00	219	305	344
26.00	257	358	404
28.00	298	416	469
32.00	389	543	612

Note:

All intermediate sizes are also available and all the above ropes are galvanised only

ROUND STRAND

6 x 21F (10-5F-5-1)



NOM. ROPE DIA	APPROX. MASS Kg./100m	MINIMUM BREAKING FORCE	
		1570 N/mm ²	1770 N/mm ²
mm	STEEL CORE	kN	kN
8.00	26.8	37	41
9.00	33.9	46	52
10.00	41.8	57	65
11.00	50.6	69	78
12.00	60.2	82	93
13.00	70.7	97	109
14.00	82	112	127
16.00	107	147	165
18.00	135	186	209
19.00	151	207	233
20.00	167	229	258
22.00	202	277	312
24.00	241	330	372
26.00	283	387	436
28.00	328	449	506
32.00	428	586	661

Note:

All intermediate sizes are also available and all the above ropes are galvanised only



FLATTENED STRAND

6 x 22 (9/12-▲) &
6 x 25 (12/12-▲)FS



NOM. ROPE DIA	APPROX. MASS Kg./100m	MINIMUM BREAKING FORCE		
		1420 N/mm ²	1570 N/mm ²	1770 N/mm ²
mm	FIBRE CORE	kN	kN	kN
16	105.00	128	141	159
18	133.00	161	179	201
20	164.00	199	220	249
22	198.00	241	267	301
24	236.00	287	317	358
25	256.00	312	344	388
26	277.00	337	373	420
28	321.00	391	432	487
29	345.00	419	463	522
32	420.00	510	564	636
33	446.00	543	600	677
35	502.00	611	675	761
36	531.00	646	714	805
37	561.00	682	754	851
38	592.00	720	796	897
40	656.00	797	882	994

Note:

All intermediate sizes are also available

FLATTENED STRAND

6 x 22 (9/12-▲) &
6 x 25 (12/12-▲)FS



NOM. ROPE DIA	APPROX. MASS Kg./100m	MINIMUM BREAKING FORCE		
		1420 N/mm ²	1570 N/mm ²	1770 N/mm ²
mm	STEEL CORE	kN	kN	kN
16	114.00	135	150	169
18	145.00	171	189	213
20	179.00	211	234	263
22	216.00	256	283	319
24	257.00	304	336	379
25	279.00	330	365	412
26	302.00	357	395	445
28	350.00	414	458	516
29	376.00	444	491	554
32	458.00	541	598	674
33	487.00	575	636	717
35	548.00	647	715	807
36	579.00	685	757	853
37	612.00	723	800	901
38	645.00	763	843	951
40	715.00	845	934	1054

Note:

All intermediate sizes are also available



SHIPPING ROPE

6 x 24 (15/9/Fibre)



NOM. ROPE DIA	APPROX. MASS Kg./100m	MINIMUM BREAKING FORCE	
		1420 N/mm ²	1570 N/mm ²
mm	FIBRE CORE	kN	kN
8.00	20.40	25	28
9.00	25.80	32	36
10.00	31.80	40	44
11.00	38.50	48	53
12.00	45.80	57	63
14.00	62.40	78	86
16.00	81.50	102	113
18.00	103.00	129	143
20.00	127.00	159	176
22.00	154.00	193	213
24.00	183.00	229	253
26.00	215.00	269	297
28.00	250.00	312	345
32.00	326.00	407	450
36.00	413.00	516	570
40.00	509.00	637	704

Note:

All intermediate sizes are also available and all the above ropes are galvanised only

FISHING ROPE

6 x 24 (15/9-FC)
& 6 x 24S (12-12-FC)



NOM. ROPE DIA	APPROX. MASS Kg./100m	MINIMUM BREAKING FORCE		
		1420 N/mm ²	1570 N/mm ²	1770 N/mm ²
mm	FIBRE CORE	kN	kN	kN
8.00	19.7	25.4	28.1	31.7
9.00	24.9	32.2	35.6	40.1
10.00	30.8	39.8	44	49.6
11.00	37.3	48.1	53.2	60
12.00	44.4	57.3	63.3	71.4
13.00	52.1	67.2	74.3	83.8
14.00	60.4	77.9	86.2	97.1
16.00	78.8	102	113	126.9
18.00	99.8	129	142	160.6
19.00	111	144	159	178.9
20.00	123	159	176	198.2
22.00	149	192	213	239.9
24.00	177	229	253	285.5
26.00	208	269	297	335
28.00	241	312	345	388.6
32.00	315	407	450	507.5

Note:

All intermediate sizes are also available and all the above ropes are galvanised only



FISHING ROPE

6 x 26WS (10-5+5-5-1)
COMPACTED



NOM. ROPE DIA	APPROX. MASS Kg./100m		MINIMUM BREAKING FORCE	
	POLY CORE	CWR	POLY CORE kN	CWR kN
mm	POLY CORE	CWR	kN	kN
14.0	82	92	128.0	141.0
16.0	106	119	167.0	184.0
18.0	136	152	212.0	234.0
20.0	167	186	261.0	290.0
22.0	203	226	316.0	352.0
24.0	241	268	376.0	416.0
26.0	283	316	442.0	495.0
28.0	331	367	512.0	563.0
30.0	380	423	588.0	657.0

Note:

Dual Tensile - outer wires: 1570 N/mm²

inner wires: 2160 N/mm²

All intermediate sizes are also available
and all the above ropes are galvanised only

ROUND STRAND

6/29F (14-7F+7-1)



NOM. ROPE DIA	APPROX. MASS Kg./100m	MINIMUM BREAKING FORCE		
		1570 N/mm ²	1770 N/mm ²	1960 N/mm ²
mm	FIBRE CORE	kN	kN	kN
10	37.9	53	59	66
11.2	47.5	66	74	82
12.5	59.8	82	93	102
14	75.0	103	116	128
16	98.7	135	152	168
18	122	170	192	213
20	152	210	237	262
22.4	190	263	297	329
25	238	328	370	410
28	299	412	464	514
30	343	473	533	590
31.5	378	522	588	651
33.5	428	590	665	736
35.5	481	662	746	826
37.5	536	739	833	922
40	611	841	948	1050
42.5	690	949	1070	1185
45	774	1064	1200	1329
47.5	862	1189	1340	1484
50	954	1313	1480	1639
51	993	1363	1537	1702
53	1073	1472	1660	1838
56	1198	1650	1860	2060
60	1375	1889	2130	2359

Note:

All intermediate sizes are also available



ROUND STRAND

6/29F (14-7F+7-1)



NOM. ROPE DIA	APPROX. MASS Kg./100m	MINIMUM BREAKING FORCE		
		1570 N/mm ²	1770 N/mm ²	1960 N/mm ²
mm	STEEL CORE	kN	kN	kN
10	42.4	60	68	73
11.2	53.5	75	85	92
12.5	66.7	94	106	115
14	83.7	118	133	144
16	107	153	173	188
18	137	194	219	238
20	169	240	271	294
22.4	214	302	340	369
25	264	375	423	459
28	331	471	531	576
30	379	540	609	661
31.5	430	596	672	729
33.5	473	674	760	825
35.5	530	757	853	926
37.5	592	844	952	1033
40	674	958	1080	1172
42.5	761	1082	1220	1324
45	852	1215	1370	1487
47.5	949	1357	1530	1660
50	1052	1499	1690	1834
51	1097	1561	1759	1909
53	1185	1685	1900	2062
56	1322	1880	2120	2301
60	1518	2164	2440	2648

Note:

All intermediate sizes are also available

HYFLEX 6/29Fi

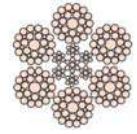

NOM. ROPE DIA	APPROX. MASS Kg./100m	MINIMUM BREAKING FORCE	
		1620 N/mm ²	1770 N/mm ²
mm	Kg./100m	kN	kN
10	44	63.6	67.7
11.2	55.2	79.8	84.9
12.5	68.8	99.4	106
14	86.3	125	133
16	113	163	173
18	143	206	219
20	176	254	271
22.4	221	319	340
25	275	398	423
28	345	499	531
30	396	573	609
31.5	437	631	672
33.5	494	714	760
35.5	555	802	853
37.5	619	895	952
40	704	1020	1080
42.5	795	1150	1220
45	891	1290	1370
47.5	993	1440	1530
50	1100	1590	1690
53	1240	1790	1900
56	1380	2000	2120
60	1580	2290	2440

Note:

Rope Sizes and Breaking Force not shown in the standard table, may be available on request and prior confirmation.



ROUND STRAND

6/36SW (14-7+7-1)



NOM. ROPE DIA	APPROX. MASS Kg./100m	MINIMUM BREAKING FORCE		
		1570 N/mm ²	1770 N/mm ²	1960 N/mm ²
mm	FIBRE CORE	kN	kN	kN
8	24.32	33.3	37	41
9	30.78	42.1	47	53
10	38.0	52.0	58	65
11	46.0	62.9	70	79
12	54.7	74.4	84	93
13	64.3	87.9	98	110
14	74.5	101	114	127
16	97.3	133	149	166
18	123	168	189	209
20	152	203	234	259
22	184	250	282	313
24	219	298	336	372
25	238	325	363	406
28	298	405	458	507
32	389	530	598	662
36	493	670	757	838
38	549	748	843	934
40	608	828	934	1035
44	736	1000	1130	1252
46	804	1100	1227	1375
48	876	1190	1350	1490
52	1030	1400	1580	1748
56	1190	1620	1830	2028
60	1369	1865	2102	2328
64	1557	2121	2392	2648

Note:

All intermediate sizes are also available

ROUND STRAND

6/36SW (14-7+7-1)

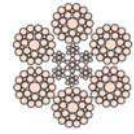

NOM. ROPE DIA	APPROX. MASS Kg./100m	MINIMUM BREAKING FORCE		
		1570 N/mm ²	1770 N/mm ²	1960 N/mm ²
mm	STEEL CORE	kN	kN	kN
8	26.77	36	41	45
9	33.80	45	52	57
10	41.84	56	63	70
11	50.58	68	76	85
12	60.20	81	90	101
13	70.65	95	107	118
14	82	109	124	137
16	107	143	161	179
18	135	181	204	226
19	153	192	216	240
20	167	221	252	279
22	202	271	304	338
24	241	322	363	402
25	262	349	394	436
28	328	438	493	548
32	428	571	644	715
36	542	724	816	905
38	604	808	911	1008
40	669	894	1009	1117
44	810	1080	1220	1352
46	885	1184	1334	1478
48	964	1290	1450	1609
52	1130	1510	1710	1888
56	1310	1750	1980	2190
58	1405	1877	2124	2349
60	1506	2014	2270	2514
76	2415	3231	3643	4034
80	2675	3580	4036	4469

Note:

All intermediate sizes are also available

The following construction holds good for the above chart:

6x41/6x47/6x43/6x49/6x52 SW - 38-90mm & 6x61SW - 57-125mm



TITAN RISER TENSIONER ROPES



6 x 37 class rope with CWR (IWRC) (Bright or galvanised)

NOMINAL ROPE DIA		APPROX. MASS	MINIMUM BREAKING FORCE
Inch.	mm	Kg./100m	kN
1	26	275	458
1 - 1/4	32	430	711
1 - 1/2	38	619	1010
1 - 5/8	42	726	1170
1 - 3/4	45	844	1360
1 - 7/8	48	967	1550
2	52	1100	1760

TYPICAL EXAMPLE

Class	Construction		Nominal Rope Dia	
	Rope	Strand	Inch.	mm
6 x 37	6 x 36 WS	14-7+7-7-1	1 - 1 3/4	26 - 45
	6 x 41 WS	16-8+8-8-1	1 3/4 - 2	45 - 52

HYFLEX 6 x 36

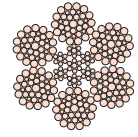

NOM. ROPE DIA	NOM. ROPE DIA	APPROX. MASS	MINIMUM BREAKING FORCE	
			1770 N/mm ²	1960 N/mm ²
mm	in	Kg./100m	kN	kN
8		26.1	40.3	44.7
9		33.2	51.0	56.5
10		40.8	63.0	69.8
11		49.4	76.2	84.4
12		58.8	90.7	101
	1/2	66.0	102	113
13		69.2	107	118
14		80.2	124	137
16	5/8	104	161	179
18		132	204	226
20		163	252	279
22		197	305	338
	7/8	201	311	345
24	15/16	235	363	402
	1	263	407	450
26		276	426	472
28		320	494	547
32	1.1/4	418	645	715
36		531	817	904
40		655	1010	1120
44		793	1220	1350
48	1.7/8	943	1450	1610
52		1111	1700	1890
56		1281	1980	2190
60	2.3/8	1471	2270	2510

Note:

Rope Sizes and Breaking Force not shown in the standard table, may be available on request and prior confirmation.



SPECIAL MINING ROPES

MINESFLEX 6



CONSTR.	NOMINAL ROPE DIA		APPROX. MASS Kg./100m	MINIMUM BREAKING FORCE	
	mm	Inch.		kN	MT
6x37SF	38	1 - 1/2	597	912	93
	40	1 - 5/8	662	1010	103
	42		705	1069	109
	44	1 - 3/4	730	1109	113
	46	1 - 7/8	801	1216	124
	48		875	1334	136
	50	2	953	1452	148
	52	2 - 1/8	1034	1579	161
	54		1067	1628	166
	56		1118	1707	174
58	1206		1834	187	
6x43SF	60	2 - 1/4	1297	1982	202
	62	2 - 3/8	1363	2070	211
	64		1403	2139	218
	66	2 - 1/2	1502	2286	233
	68	2 - 5/8	1604	2443	249
	70		1656	2521	257
6x57SF	72	2 - 3/4	1709	2600	265
	74		1884	2835	289
			2057	3090	315

Note:

Sizes and breaking load values not shown above are also available on request.

ROUND STRAND

6/37M (18/12/6-1)

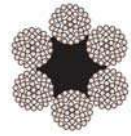

NOM. ROPE DIA	APPROX. MASS Kg./100m	MINIMUM BREAKING FORCE		
		1570 N/mm ²	1770 N/mm ²	1960 N/mm ²
mm	FIBRE CORE	kN	kN	kN
6	12.5	17.5	18.8	21
8	22.1	30	33	37
10	34.6	46	52	58
12	49.8	67	75	83
14	67.8	91	102	113
16	88.6	118	134	148
18	112	150	169	187
20	138	185	209	231
22	167	224	253	280
24	199	267	301	333
26	234	313	353	391
28	271	363	409	453
30	311	417	469	520
32	354	474	534	592
36	448	600	676	749
38	500	668	753	834
40	554	741	835	924
42	611	816	920	1020
44	670	896	1010	1119
46	732	979	1104	1222
48	797	1066	1202	1331
52	936	1252	1411	1562
56	1090	1451	1636	1812
60	1250	1666	1878	2080
64	1420	1896	2137	2367

Note:

All intermediate sizes are also available



ROUND STRAND

6/37M (18/12/6-1)



NOM. ROPE DIA	APPROX. MASS Kg./100m	MINIMUM BREAKING FORCE		
		1570 N/mm ²	1770 N/mm ²	1960 N/mm ²
mm	STEEL CORE	kN	kN	kN
6	13.7	17.7	20	23
8	24.4	32	36	40
10	38.1	50	56	62
12	54.8	72	81	90
14	74.6	98	110	122
16	97.4	128	144	160
18	123	162	183	202
20	152	200	225	250
22	184	242	273	302
24	219	288	325	359
26	257	338	381	422
28	298	392	442	489
30	342	450	507	562
32	390	512	577	639
36	493	648	730	809
38	550	722	814	901
40	609	800	902	999
42	670	882	994	1101
44	737	968	1090	1208
46	804	1058	1192	1321
48	877	1150	1300	1438
52	1029	1350	1520	1687
56	1190	1570	1770	1957
60	1370	1800	2030	2246
64	1560	2050	2310	2555

Note:

All intermediate sizes are also available

SHIPPING ROPE

6 x 37M (18/12/6/1)



NOM. ROPE DIA	APPROX. MASS Kg./100m	MINIMUM BREAKING FORCE	
		1420 N/mm ²	1570 N/mm ²
mm	FIBRE CORE	kN	kN
12.00	49.80	60	67
14.00	67.80	82	91
16.00	88.60	107	118
18.00	112.00	136	150
20.00	138.00	167	185
22.00	167.00	203	224
24.00	199.00	241	267
26.00	234.00	283	313
28.00	271.00	328	363
32.00	354.00	429	474
36.00	448.00	543	600
40.00	554.00	670	741
44.00	670.00	810	896
48.00	797.00	964	1066
52.00	936.00	1132	1252
56.00	1085.00	1313	1451

Note:

All intermediate sizes are also available and all the above ropes are galvanised only



CONVEYOR CORD

7X7



CORD DIA	MIN. BREAKING LOAD	STEEL SECTION	LINEAR DENSITY
mm	kN	(mm ²)	(g/m)
1.62	3.00	1.23	10
1.92	4.60	1.94	14
2.80	8.00	3.53	29
3.50	12.80	5.64	46
3.60	13.40	6.15	50
3.70	14.50	6.34	52
3.80	15.00	6.65	55
4.00	16.70	7.79	64
4.10	17.60	7.75	64
4.40	19.80	9.19	76
4.50	20.80	9.48	79
4.80	23.30	10.76	88
5.00	25.20	11.60	95
5.20	26.70	12.76	105
5.30	27.70	13.21	108
5.40	29.70	13.49	111
5.50	29.90	14.24	117

- Drawn Galvanised.
- Quality of zinc suits rubber adhesion.
- Excellent pull-out test before & after ageing.
- Excellent dynamic cycle.
- Linear density is approximate & for guidance only.

Note:

All intermediate sizes are also available

CONVEYOR CORD

7X19



CORD DIA	MIN. BREAKING LOAD	STEEL SECTION	LINEAR DENSITY
mm	kN	(mm ²)	(g/m)
6.00	33.50	15.71	131
6.40	37.40	17.55	147
6.80	43.00	20.27	169
7.00	46.20	21.21	176
7.60	53.00	24.65	204
8.10	57.70	28.54	238
8.80	67.60	33.39	279
9.30	79.20	36.39	302
9.50	79.20	38.26	320
9.60	86.40	40.01	330

- Drawn Galvanised.
- Quality of zinc suits rubber adhesion.
- Excellent pull-out test before & after ageing.
- Excellent dynamic cycle.
- Linear density is approximate & for guidance only.

Note:

All intermediate sizes are also available



ROUND STRAND BRIDGE ROPES



7X37

NOM. ROPE DIA	APPROX. MASS Kg./100m	MINIMUM BREAKING FORCE	
		1570 N/mm ²	
		kN	
25	238	340	
28	299	426	
32	391	556	
35	467	665	
38	550	784	
40	610	869	
42	673	958	
44	738	1050	
48	878	1250	
50	953	1360	

- 6 Strand ropes with steel strand core, galvanised and pre stretched with end fittings in ready to install condition construction - 7 x 37 (18 : 12 : 6 -1).
- Bridge ropes in 7 x 19 (12 : 6 - 1) & 7 x 7 (6 -1) constructions with wire strand core fully galvanised and prestretched and end fittings in ready to install condition are also available.
- Special requirements on breaking forces can also be met.
- Round Strand Bridge Ropes may be provided conforming to various relevant national and international standards to suit customer needs.
- Round Strand Bridge Ropes can also be provided in sizes and constructions not included in the table above.

POWERFORM 8/8P

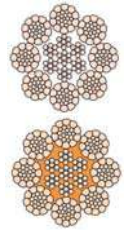

NOM. ROPE DIA	NOM. ROPE DIA	APPROX. MASS Kg./100m	MINIMUM BREAKING FORCE	
			1960 N/mm ²	2160 N/mm ²
			kN	kN
10		46.0	87.8	94.0
12		66.2	126	135
14	1/2	74.2	142	152
16	5/8	90.2	172	184
19	3/4	118	225	241
20		166	317	339
22		184	351	376
24	7/8	223	425	455
26		227	434	464
28	1	265	506	541
30		297	567	606
32	1-1/8	318	594	635
34		368	688	737
36	1-1/4	384	717	767
38		423	790	846
40	1-1/2	481	899	960
42		543	1013	1083
44	1-3/4	609	1138	1218
46		679	1268	1357
48		752	1405	1503
50	2	929	1700	1819
52		948	1735	1856
		1016	1858	1985
		1106	2023	2162
		1200	2200	2349
		1239	2266	2425
		1298	2374	2541

Note:

'P' signifies full Plastic impregnation of steel core.

POWERFORM 8P is available only for 16 mm & above. Rope Sizes and MBL not shown above are also available on request and prior confirmation.

Mass per unit length of POWERFORM 8P increases by approx. 3%



HYFLEX 8/8P

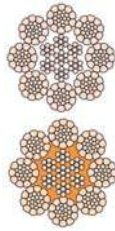

NOM. ROPE DIA	NOM. ROPE DIA	APPROX. MASS	MINIMUM BREAKING FORCE	
			1960 N/mm ²	2160 N/mm ²
mm	in	Kg./100m	kN	kN
10		43.5	72.9	81.4
12		62.6	105	117
	1/2	70.2	123	131
14		85.3	143	160
16	5/8	111	187	208
18		141	239	267
19	3/4	157	269	300
22		211	356	400
	7/8	215	360	402
24		251	423	475
	1	281	470	525
26		297	500	562
28		345	572	642
	1-1/8	359	596	665
30		396	656	733
32	1-1/4	451	747	836
36		570	935	1053
38	1-1/2	635	1043	1172
42		785	1305	1462
44		862	1412	1577
	1-3/4	879	1441	1613
48		1025	1680	1885
50		1113	1833	2065
	2	1148	1882	2101
52		1203	1972	2202

Note:

'P' signifies full Plastic impregnation of steel core.

POWERFORM 8P is available only for 16 mm & above. Rope Sizes and MBL not shown above are also available on request and prior confirmation.

Mass per unit length of POWERFORM 8P increases by approx. 3%

POWERFORM 8PC

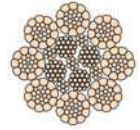

NOM. ROPE DIA	NOM. ROPE DIA	APPROX. MASS	MINIMUM BREAKING FORCE	
			1960 N/mm ²	2160 N/mm ²
mm	in	Kg./100m	kN	kN
8		31.7	60.5	66.5
9		40.1	76.6	84.2
10		49.5	94.7	103
11		59.9	112	121
12	1/2	71.3	138	150
		79.8	152	164
13		83.7	159	172
14		97.0	181	197
15		111	213	232
16	5/8	127	239	260
17		143	269	292
18		160	300	326
19	3/4	179	341	371
20		198	375	408
22		240	448	487
	7/8	245	457	497
24		285	527	574
	1	319	592	646
26		335	620	677
28		388	735	801

Note:

'PC' signifies Parallel Closed rope.

Rope Sizes and Breaking Force not shown in the standard table, may be available on request and prior confirmation.



SPECIAL MINING ROPES

MINESFLEX 8



CONSTR.	NOMINAL ROPE DIA		APPROX. MASS Kg./100m	MINIMUM BREAKING FORCE		
	mm	Inch.		kN	MT	
8x37SF	38	1-1/2	599	872	88.9	
	40	1 - 5/8	664	961	98	
	42		707	1030	105	
	44	1 - 3/4	732	1069	109	
	46	1 - 7/8	804	1167	119	
	48		878	1275	130	
	50	2	956	1393	142	
	52		1038	1511	154	
	54	2 - 1/8	1071	1560	159	
	56	2 - 1/4	1123	1628	166	
	58		1211	1756	179	
	60	2 - 3/8	1211	1756	179	
	62	2 - 1/2	1302	1893	193	
	63		1356	1972	201	
	64	1397	2031	207		
	8x50SF	67	2 - 5/8	1513	2197	224
		70	2 - 3/4	1615	2345	239
		76	2-7/8	1668	2423	247
3			1721	2502	255	
83		3 - 1/4	2766	282		
86		3 - 3/8	2079	3021	308	

Note:

Sizes and breaking load values not shown above are also available on request.

SPECIAL MINING ROPES

MINESFORM 8 PVF

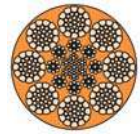

CONSTR.	NOMINAL ROPE DIA		APPROX. MASS Kg./100m	MINIMUM BREAKING FORCE		
	mm	Inch.		kN	MT	
8x37SF	38	1 - 1/2	639	981	100	
	40	1 - 5/8	708	1089	111	
	42		754	1148	117	
	44	1 - 3/4	780	1197	122	
	46	1 - 7/8	856	1344	137	
	48		936	1422	145	
	50	2	1019	1550	158	
	52		1106	1678	171	
	54	2	1141	1727	176	
	56	2 - 1/8	1196	1815	185	
	58		1290	1962	200	
	60	2 - 1/4	1387	2099	214	
	62	2 - 3/8	1445	2188	223	
	63		1488	2256	230	
	64	1604	2433	248		
	8x50SF	67	2 - 1/2	1712	2600	265
		70	2 - 5/8	1768	2688	274
		72	2 - 3/4	1812	2737	279
76		2 - 7/8	2002	3012	307	
		3	2185	3120	318	
83		3 - 1/8	2312	3296	336	
86	3 - 1/4	2379	3394	346		
8x50SF	67	3	2576	3561	363	
	70	3 - 1/8	2810	3885	396	
	72	3 - 1/4	3073	4248	433	
	76	3 - 1/2	3299	4562	465	
		3 - 3/8				

Note:

'PVF' signifies fully Plasticated & Valley Filled
 Sizes and breaking load values not shown above are also available on request.



HOIST & COMPENSATING ROPE

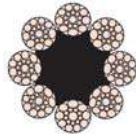

8 x 19S (9-9-1)

NOM. ROPE DIA	APPROX. MASS Kg./100m	MINIMUM BREAKING FORCE (KN)
mm	FIBRE CORE (CFN)	1570 or 1370 / 1770 N/mm ²
8	22.20	28.10
9	27.00	36.20
9.5	31.00	39.80
10	34.70	44.00
11	42.00	53.20
12	50.30	64.00
12.7	56.00	71.50
13	58.50	74.80
14	66.00	86.20
16	88.80	113.00
18	109.00	141.00
20	135.00	178.00
22	165.00	213.00
24	184.00	233.00
25.4	217.00	254.00

HOIST & COMPENSATING ROPE



8 x 19S (9-9-1) + IWRC

NOM. ROPE DIA	APPROX. MASS Kg./100m	MINIMUM BREAKING FORCE (KN)
mm	STEEL CORE (CFN)	1570 or 1370 / 1770 N/mm ²
6.5	16.10	24.70
8	24.00	36.20
9	30.70	46.00
10	38.50	57.60
11	46.60	69.90
12	55.10	82.70
13	65.60	98.20
14	75.30	113.60
16	98.40	147.40
18	123.00	184.40
20	153.00	230.00



GOVERNOR ROPES

6/25F (12-6F+6-1)

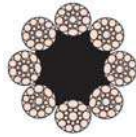

NOM. ROPE DIA	APPROX. MASS Kg./100m	MINIMUM BREAKING FORCE		
		1570 N/mm ²	1770 N/mm ²	1960 N/mm ²
mm	FIBRE CORE	kN	kN	kN
6	12.5	-	19.6	-
7	18.0	-	29.5	-
8	22.1	-	34.8	-
10	35.2	-	54.4	-
12	49.8	-	78	-

8/19S (9-9-1)

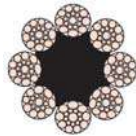

NOM. ROPE DIA	APPROX. MASS Kg./100m	MINIMUM BREAKING FORCE		
		1570 N/mm ²	1770 N/mm ²	1960 N/mm ²
mm	FIBRE CORE	kN	kN	kN
8	22.2	-	28.1	-
9.5	31.0	-	39.8	-
11	42.0	-	53.2	-
12.7	56.0	-	71.5	-

Note:

Measured rope diameter will be in the range of +2.5% to +5% of nominal rope diameter under no-load condition

POWERFORM 18

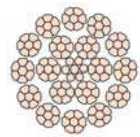

NOM. ROPE DIA	NOM. ROPE DIA	APPROX. MASS Kg./100m	MINIMUM BREAKING FORCE	
			1960 N/mm ²	2160 N/mm ²
mm	in	Kg./100m	kN	kN
6		17.5	29.4	
7		23.8	38.0	
8		31.0	51.8	
9		39.3	64.6	
10		48.5	80.8	
11		58.7	101	111
12		69.8	116	127
13	1/2	78.2	135	148
14		82.0	141	155
15		95.1	160	177
16	5/8	109	182	201
17		124	209	232
18		140	237	262
		157	266	295
	3/4	175	291	322
20		194	320	359
22		235	379	424
	7/8	240	387	433
24		279	462	523
	1	313	517	585
26		328	542	613
28		380	632	710
30		437	721	809
32	1-1/4	497	820	920

Note:

'P' signifies full plastic impregnation of the steel core

Rope Sizes and Breaking Force not shown in the standard table may be available on request and prior confirmation.



HYFLEX 18

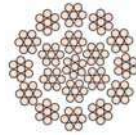

NOM. ROPE DIA	NOM. ROPE DIA	APPROX. MASS	MINIMUM BREAKING FORCE	
			1960 N/mm ²	2160 N/mm ²
mm	in	Kg./100m	kN	kN
6		14.6	25.0	27.0
7		19.9	34.0	36.7
8		26.0	45.0	48.6
9		32.9	56.5	61.0
10		40.6	70.0	75.6
11		49.1	84.0	90.7
12	1/2	58.5	101	109
13		65.5	113	121
14		68.6	118	127
15		79.6	137	148
16	5/8	91.4	157	169
17		104	180	194
18		117	203	219
18	3/4	132	226	244
20		147	253	273
22		162	279	301
22	7/8	197	339	366
		201	346	374

Note:

Rope Sizes and Breaking Force not shown in the standard table, may be available on request and prior confirmation.

POWERFORM 35/35P

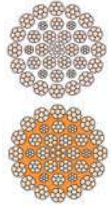

NOM. ROPE DIA	NOM. ROPE DIA	APPROX. MASS	MINIMUM BREAKING FORCE	
			1960 N/mm ²	2160 N/mm ²
mm	in	Kg./100m	kN	kN
10		50.3	90.5	98.6
11		60.7	111	119
12		72.9	131	141
	1/2	81.1	148	160
14		98.6	180	192
16	5/8	129	233	252
18		163	300	321
19	3/4	182	331	358
20		201	372	399
22		243	444	484
	7/8	249	453	490
24		290	531	572
	1	325	591	640
26		340	621	661
28		394	720	788
	1-1/8	411	748	810
30		453	827	904
32	1-1/4	515	944	1035
35	1-3/8	616	1125	1216
38	1-1/2	726	1326	1437
40		805	1477	1588
42		887	1485	1620
	1-3/4	994	1646	1800
46		1064	1765	1930
48		1159	1935	2120
	2	1298	2150	2325
52		1360	2256	2450

Note:

POWERFORM 35P is available on special request and prior confirmation.

Rope Sizes and Breaking Force not shown in the standard table, may be available on request and prior confirmation.

Mass per unit length of Powerform 35P increases by approx. 3%.

Preferred construction 35x7 upto 42mm & 35x19S for higher sized.



HYFLEX 35/35P



NOM. ROPE DIA	NOM. ROPE DIA	APPROX. MASS	MINIMUM BREAKING FORCE	
			1960 N/mm ²	2160 N/mm ²
mm	in	Kg./100m	kN	kN
10		44.8	76.0	86.5
12		64.5	107	125
14	1/2	72.0	123	137
16	5/8	88.0	148	168
19	3/4	115	194	221
20		162	277	312
22		179	301	337
24	7/8	217	370	412
26		221	376	418
28	1	258	441	498
30		289	491	546
32	1-1/8	303	517	581
35		351	599	681
36		366	621	704
38	1-1/4	403	679	775
42		459	769	865
44	1-3/8	549	945	1044
48		581	983	1085
52	1-1/2	647	1078	1205
		790	1227	
		867	1347	
	1-3/4	885	1375	
		1032	1603	
	2	1156	1796	
		1211	1881	

Note:

'P' signifies full plastic impregnation of the steel core

HYFLEX 35P is available on special request and prior confirmation.

Rope Sizes and Breaking Force not shown in the standard table, may be available on request and prior confirmation.

Mass per unit length of HYFLEX 35P increases by approx. 3%

LOCKED COIL TRACK ROPES & STRUCTURAL ROPES

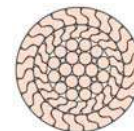

NOM. ROPE DIA	APPROX. MASS	MINIMUM BREAKING FORCE		
		1370 N/mm ²	1470 N/mm ²	1570 N/mm ²
mm	UNGALV.	kN	kN	kN
25	350	520	558	596
26	379	562	603	644
28	440	652	700	747
29	472	699	750	801
30	505	748	803	858
32	574	851	914	976
34	648	961	1030	1100
35	687	1020	1090	1170
36	727	1080	1160	1230
37	768	1140	1220	1300
38	810	1200	1290	1380
39	853	1260	1360	1450
40	897	1330	1430	1520
42	989	1470	1570	1680
43	1040	1540	1650	1760
44	1090	1610	1730	1840
45	1140	1680	1810	1930
46	1190	1760	1890	2020
48	1290	1920	2060	2200
50	1400	2080	2230	2380
52	1520	2250	2410	2580
54	1640	2420	2600	2780
55	1700	2520	2700	2880
56	1760	2610	2800	2990
58	1890	2800	3000	3210
60	2020	2990	3210	3430
61	2190	3240	3480	3710
62	2260	3350	3590	3840
64	2410	3570	3830	4090
65	2480	3680	3950	4220
66	2560	3790	4070	4350

* Heavy galvanized structural rope mass increases by around 5%.



LOCKED COIL TRACK ROPES & STRUCTURAL ROPES

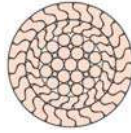

NOM. ROPE DIA	APPROX. MASS Kg./100m	MINIMUM BREAKING FORCE		
		1370 N/mm ²	1470 N/mm ²	1570 N/mm ²
mm	UNGALV.	kN	kN	kN
68	2720	4030	4320	4620
69	2800	4150	4450	4750
70	2880	4270	4580	4890
72	3050	4520	4850	5180
74	3220	4770	5120	5470
75	3300	4900	5260	5620
76	3390	5030	5400	5770
77	3480	5160	5540	5920
78	3570	5300	5690	6070
79	3670	5440	5830	6230
80	3760	5580	5980	6390
82	3950	5860	6290	6710
84	4150	6150	6600	7040
86	4340	6440	6910	7380
88	4550	6750	7240	7730
89	4650	6900	7400	7910
90	4760	7060	7570	8090
92	5030	7460	8000	8550
94	5250	7780	8350	8920
96	5480	8120	8710	9300
97	5590	8290	8890	9500
98	5710	8460	9080	9700
99	5820	8630	9270	9900
100	5940	8810	9450	10100
101	6060	8990	9640	10300
102	6180	9170	9840	10500
103	6300	9350	10000	10700

* Heavy galvanized structural rope mass increases by around 5%.

LOCKED COIL TRACK ROPES & STRUCTURAL ROPES

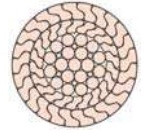

NOM. ROPE DIA	APPROX. MASS Kg./100m	MINIMUM BREAKING FORCE		
		1370 N/mm ²	1470 N/mm ²	1570 N/mm ²
mm	UNGALV.	kN	kN	kN
104	6430	9530	10200	10900
105	6550	9710	10400	11100
106	6680	9900	10600	11300
107	6800	10100	10800	11600
108	6930	10300	11000	11800
109	7060	10500	11200	12000
110	7190	10700	11400	12200
111	7320	10900	11600	12400
112	7450	11100	11900	12700
113	7590	11200	12100	12900
114	7720	11400	12300	13100
115	7860	11700	12500	13400
116	7990	11900	12700	13600
117	8130	12100	12900	13800
118	8270	12300	13200	14100
119	8410	12500	13400	14300
120	8560	12700	13600	14500
121	8700	12900	13800	14800
122	8840	13100	14100	15000
123	8990	13300	14300	15300
124	9140	13500	14500	15500
125	9280	13800	14800	15800
130	10200	15100	16200	17300
135	11000	16200	17400	18600
140	11800	17500	18700	20000

* Heavy galvanized structural rope mass increases by around 5%.



LOCKED COIL WINDING ROPES

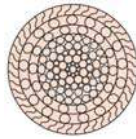

NOM. ROPE DIA	APPROX. MASS Kg./100m	MINIMUM BREAKING FORCE	
		1570 N/mm ²	
mm	UNGALV.	kN	
16	148	208	
18	188	264	
19	209	294	
20	232	326	
21	256	359	
22	281	394	
24	334	469	
25	363	509	
26	392	550	
27	423	593	
28	447	638	
29	479	685	
30	513	733	
32	584	834	
34	659	941	
35	698	997	
36	739	1055	
37	780	1114	
38	823	1176	
39	867	1238	
40	912	1303	
42	1005	1436	
44	1104	1576	
46	1206	1723	
48	1313	1876	
51	1483	2117	
54	1662	2374	
57	1852	2645	
60	2052	2931	

Note:

All intermediate sizes are also available

LOCKED COIL GUIDE ROPES

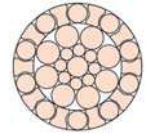

NOM. ROPE DIA	APPROX. MASS Kg./100m	MINIMUM BREAKING FORCE	
		700 - 900 N/mm ²	800 - 950 N/mm ²
mm	UNGALV. / GALV.	kN	kN
29	456	319	386
32	558	387	473
35	711	473	580
38	840	560	686
41	977	666	811
44	1125	772	937
48	1339	879	1081
50	1453	1004	1229
54	1696	1159	1419

Note:

All intermediate sizes are also available



WHY USHA MARTIN ROPE?

- Guaranteed Raw Material Quality
 - Developed, manufactured and quality certified by own Steel Plant.
 - Tailor made raw materials to ensure consistent rope quality and desired end-properties
- Guaranteed Product Quality
 - State-of-the-art pickling plant.
 - State-of-the-art patenting furnaces.
 - Latest generation wire-drawing machinery
 - Computerised rope design.
 - In-house developed rope making machinery for manufacturing high-performance ropes.
 - Breaking load and fatigue test equipment to guarantee desired performance and quality.
- Guaranteed Quality systems
 - ISO 9001:2008
 - API
 - OTIS
 - ABS
 - LLOYDS
 - NKK
 - JIPM
- Robust Process Control
 - Qualified supervisors & operators trained in own institution on product process and equipment.
 - Regular training of operations staff at HRD centre.
 - Visual display of process parameters at each stage of processing.
 - Stringent quality control at every stage of manufacturing.

QUALITY POLICY

"Our quality policy is to fulfil customers' requirement through reliable products and services meeting all regulatory requirements and through continual improvement of our quality management system."

TPM POLICY

"It is our policy to induce change in all employees by delegation, empowerment and motivation to achieve total participation towards zero accident, zero defect and zero failure."



HOW TO ORDER A ROPE

- Nominal Diameter and tolerance.
- Construction/Class/Brand Name.
- Finish (galvanised or ungalvanised)
- Tensile Strength
- Minimum Breaking load requirement.
- Core – Fibre/IWRC/WSC.
- Lay - eg. Right hand regular lay.
- Lubrication
- Packing - wooden reel/steel reel/coils.
- Particulars of fittings
- Preformed /Non-preformed
- Exact length per reel / coil etc (special length tolerance, if any)
- Delivery time
- Special requirements
 - Pre-stretching
 - Packaging
 - Identification
 - Third-party inspection

Note:

It is always important to state the application of the rope other than the above points to ensure correct rope for your purpose or find out more at www.ushamartin.com

HOW TO IDENTIFY USHA MARTIN ROPE



Every genuine Usha Martin rope has this identification tape inside



SAFETY INFORMATION

- ▲ Wire rope will fail if worn out, shock loaded, overloaded, misused, damaged, improperly maintained or abused.
- ▲ Always inspect wire rope for wear, damage or abuse before use.
- ▲ Never use a wire rope which is worn out, damaged, corroded or abused.
- ▲ Never overload or shock load a wire rope.
- ▲ Use the correct design factor for the application.
- ▲ Inform yourself : Read and understand the machinery manufacturers handbook and guidance from the wire rope manufacturer.
- ▲ Refer to applicable directives, regulations, standards and codes concerning inspection, examination and rope removal criteria.

All statements, technical information and recommendations contained herein are believed to be reliable, but no guarantee is given as to their accuracy and/or completeness. The user must determine the suitability of the product for his own particular purpose, either alone or in combination with other products and shall assume all risk and liability in connection therewith.

Whilst every attempt has been made to ensure accuracy in the content of the tables, the information contained in this catalogue does not form any part of a contract.

METRIC - IMPERIAL DIAMETER CONVERSION

in.	mm.	in.	mm.	in.	mm.
5/32	3.97	15/16	23.8	2 1/2	63.5
3/16	4.76	1	25.4	2 3/4	69.9
7/32	5.56	1 1/16	27.0	3	76.2
1/4	6.35	1 1/8	28.6	3 1/4	82.6
5/16	7.94	1 3/16	30.2	3 1/2	88.9
3/8	9.53	1 1/4	31.8	3 3/4	95.3
7/16	11.1	1 3/8	34.9	4	101.6
1/2	12.7	1 1/2	38.1	4 1/4	108.0
9/16	14.3	1 5/16	41.3	4 1/2	114.3
5/8	15.9	1 3/4	44.5	4 3/4	120.7
11/16	17.5	1 7/8	47.6	5	127.0
3/4	19.0	2	50.8		
13/16	20.6	2 1/8	54.0		
7/8	22.2	2 1/4	57.2		

CONVERSION TABLE

Length	1m	= 1000 mm	= 3,281ft	= 39,37 inch
Force	1kN	= 101,97kp	= 0,10197 Mt-f	= 224lbs-f
Tensile Strength	1N/mm ²	= 0,10197 kp/mm ²	= 145,04 p.s.i.	= 10 bar
Cross Section	1 mm ²	= 0,00155 in ²		
Weight	1 metric t	= 1000 kg	= 1,102 short t	= 0,9842 long t = 2204,6 lbs
Weight per Length Unit	1 kg/m	= 0,72 lbs/ft		



NATIONAL PRESENCE

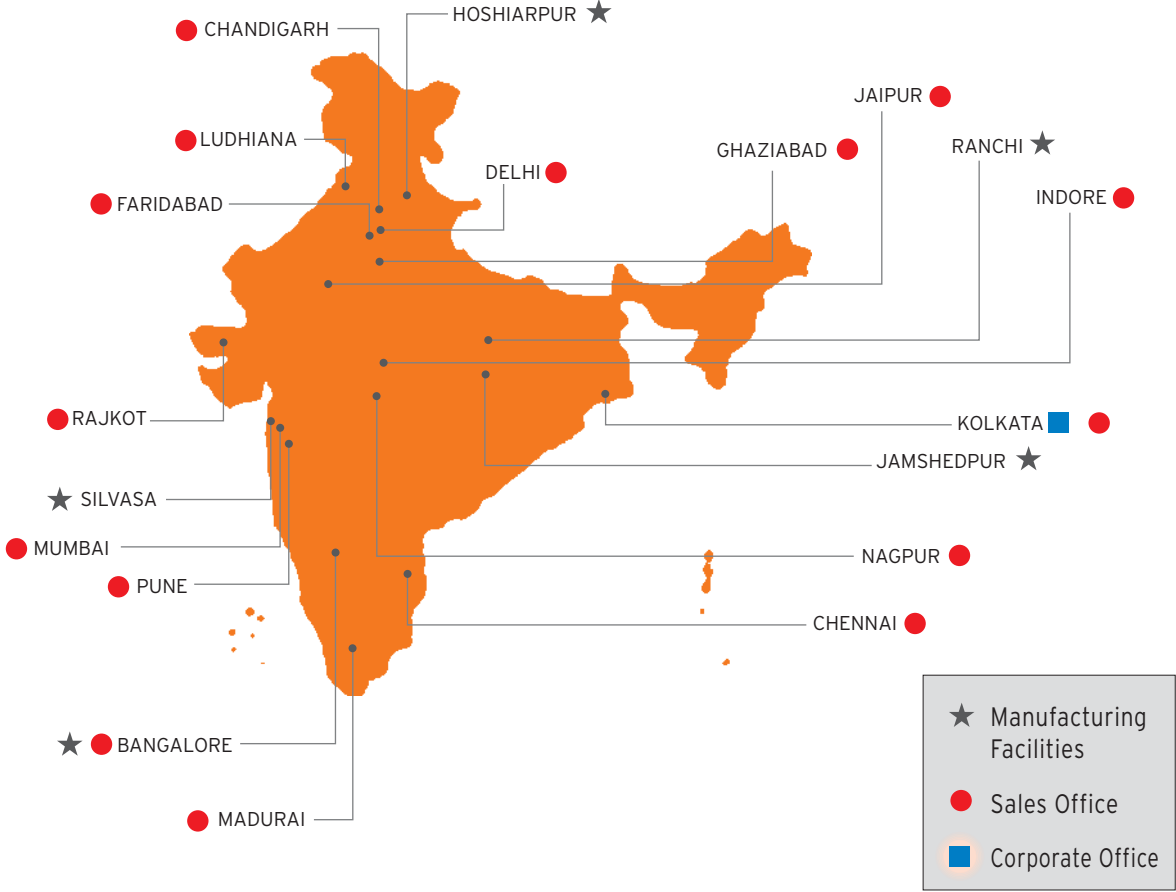

INTERNATIONAL PRESENCE



WHERE TO CONTACT US

Domestic Offices

East Regional Office

USHA MARTIN LIMITED

2A, Shakespeare Sarani
'Mangal Kalash'

Kolkata - 700071

Phone: +91 33 3980 0300/ 0458

Fax: +91 33 2282 9029/ 3980 0500

Email: marketing-east@ushamartin.com

South Regional Office

USHA MARTIN LIMITED

Plot No. L9 (1), Phase-II

Sipcot Industrial Park, Sriperumbudur

Kancheepuram - 602105

Chennai, Tamilnadu

Phone: +91 44 3717 5100 (24 Lines)

Fax: +91 44 3717 5200

Email: marketing-south@ushamartin.com

North Regional Office

USHA MARTIN LIMITED

701, 'Surya Kiran'

19, Kasturba Gandhi Marg

New Delhi - 100 001

Phone: +91 11 2331 5156 / 5157 / 5158

2371 1232 / 2371 5220

Fax: +91 11 2332 0723 / 5586

Email: marketing-north@ushamartin.com

West Regional Office

USHA MARTIN LIMITED

168, CST Road,

Agarwal Industrial Estate

Kalina, Santa Cruz (E)

Mumbai - 400 098

Phone: +91 22 3064 5400

Fax: +91 22 2652 6774

Email: marketing-west@ushamartin.com

Overseas Offices

USHA MARTIN UK LIMITED

Tasman House, Mariner Court

Clydebank, Glasgow, UK G81 2NR, UK

Tel: + 44 (0)141 951 8801

Fax: + 44 (0) 141 951 8802

Email: marketing-uk@ushamartin.com

EUROPEAN MANAGEMENT & MARINE CORP.

Howe Moss Place, Kirkhill Industrial Estate

Dyce, Aberdeen AB 21 OGS, Scotland, U.K

Ph: +44 1224 77 5151

Fax: +44 1224 775252

Email: info@emmcorp.com

BRUNTON SHAW UK

(A Division of Usha Martin UK Limited)

Sandy Lane, Workshop, S80 3ES, UK

Tel: + 44 1909 537 600

Fax: + 44 1909 500 199

Email: info@brunton-shaw.co.uk

DE RUITER STAALKABEL B.V.

Ringerstraat 7, 3164 BA, Sliedrecht

Holland

Tel: + 31 (0)184 49 9999

Fax: +31 (0) 184 41 8351

Email: sales@drstk.nl

USHA MARTIN AMERICAS, INC

701 Plastics Avenue, Houston

Texas 77020, USA

Ph: +1 713 676 1800

Fax: +1 713 676 1166

Email: marketing-us@ushamartin.com



WHERE TO CONTACT US

USHA MARTIN AUSTRALIA PTY LTD

Unit 2/ 468-470, Victoria Street
St.Wetherill Park, NSW 2164, Australia
Ph: +61 296 094971
Fax: +61 297 566516
Email: marketing-australia@ushamartin.com

USHA MARTIN SINGAPORE PTE LIMITED

91 Tuas Bay Drive, Usha Martin Building,
Singapore - 637307
Ph: +65 6265 7756
Fax: +65 6265 7226
Email: marketing-singapore@ushamartin.com

USHA MARTIN VIETNAM CO. LTD

823 Huynh Tan Phat, Hamlet 6
Phu Xuan Commune Nha Be District
Ho Chi Minh City, S.R Vietnam
Tel: +84 8 3781 8196
Fax: +84 8 3781 8171
HP: +84 903702469
Email : marketing-vietnam@ushamartin.com

PT. USHA MARTIN INDONESIA

Konica Building 3A FI
Jl. Gunung Sahari Raya 78
Jakarta 10610 - Indonesia
Ph: +62 21 42870794
Fax: +62 21 42870795
Email: marketing-indonesia@ushamartin.com

BRUNTON WOLF WIRE ROPES FZCO

P.O. Box. 17491, M00301
Jebel Ali Free Zone, Dubai, U.A.E
Tel: + 971 04 8838151
Fax: + 971 04 8838152
Email: marketing-bsme@ushamartin.com

USHA SIAM STEEL INDUSTRIES PUBLIC CO. LTD

209 K-Tower-B, 22nd Floor, Unit 3/1
Sukhumvit 21 Road (Asok)
Bangkok - 10110, Thailand
Tel: +662 261 7361 to 64
Fax: +662 640 8227
Email: marketing-thailand@ushamartin.com

USHA MARTIN EUROPE B.V.

Leerlooierstraat 3
2984 BK Ridderkerk
Holland
Phone: +31 (0)180 74 50 99
Mobile: +31 (0)635 11 29 31
E-mail: d.gelton@ushamartineurope.com

USHA MARTIN CHINA CO. LTD.

No. 122, East FuTe No. 1 Rd. Wai Gao Qiao Free Trade Zone,
Shanghai, P.R. China (Shanghi) Pilot Free Trade Zone,
Postal Code: 200131
Tel: +86 21 6858 8699
Fax: +86 21 6858 8711
Email: yhw@umchina.com.cn



NOTE

Lined writing area for notes on the left page.

NOTE

Lined writing area for notes on the right page.



